

DEPARTMENT OF THE ARMY  
 HEADQUARTERS, U.S. ARMY MEDICAL DEPARTMENT CENTER AND SCHOOL  
 FORT SAM HOUSTON, TEXAS 78234-5078

AMEDDC&S Pamphlet  
 No. 350-10

2 January 2004

Training  
**EXPERT FIELD MEDICAL BADGE (EFMB) TEST**

**TABLE OF CONTENTS**

	<u>PARA</u>	<u>PAGE</u>
<b>CHAPTER 1. GENERAL</b>		
HISTORY .....	1-1	1-1
EFMB'S HISTORY .....	1-2	1-1
PURPOSE .....	1-3	1-1
APPLICABILITY .....	1-4	1-1
REFERENCES .....	1-5	1-1
EXPLANATION OF ABBREVIATIONS AND TERMS .....	1-6	1-1
<b>CHAPTER 2. ADMINISTRATIVE REQUIREMENTS</b>		
THE EFMB .....	2-1	2-1
ELIGIBILITY .....	2-2	2-1
PROVISIONS AND AUTHORITIES .....	2-3	2-2
DUTIES .....	2-4	2-2
REQUESTING TO CONDUCT THE EFMB TEST .....	2-5	2-6
WRITTEN TEST MATERIALS .....	2-6	2-6
SECURITY OF WRITTEN TEST MATERIALS .....	2-7	2-7
VALIDATION/STANDARDIZATION REVIEW .....	2-8	2-8
EXCEPTION TO POLICY .....	2-9	2-8
REBUTTAL/APPEAL PROCEDURES .....	2-10	2-8
AWARDING THE EFMB .....	2-11	2-8
<b>CHAPTER 3. CONDUCT OF THE EFMB TEST</b>		
REQUIREMENTS .....	3-1	3-1
CLARIFICATION OF PERFORMANCE MEASURES .....	3-2	3-1
TEST PERIOD .....	3-3	3-1
TRAINING .....	3-4	3-1
EQUIPMENT .....	3-5	3-2
BATTLEFIELD SCENARIO AND COMBAT LANE CONCEPTS .....	3-6	3-2
PERFORMANCE STANDARDS .....	3-7	3-4
CHANGES .....	3-8	3-4
WRITTEN TEST .....	3-9	3-4
LAND NAVIGATION TASKS .....	3-10	3-7
COMMUNICATION TASKS .....	3-11	3-11
COMMON SKILLS TASKS .....	3-12	3-23
EMERGENCY MEDICAL TREATMENT TASKS .....	3-13	3-57
EVACUATION OF THE SICK AND WOUNDED TASKS .....	3-14	3-77
LITTER OBSTACLE COURSE TASKS .....	3-15	3-99
FOOT MARCH .....	3-16	3-121

AMEDDC&S Pam 350-10

APPENDIX A - REFERENCES

A-1

APPENDIX B - GLOSSARY

B-1

APPENDIX C - AMEDDC&S FORM 1232-R

C-1

## CHAPTER 1

### GENERAL

**1-1. HISTORY.** This is the first printing of this publication.

**1-2. EFMB'S HISTORY.** The EFMB was established in June 1965 as a Department of the Army (DA) special skill award for the recognition of exceptional competence and outstanding performance by field medical personnel. Made of oxidized silver, the badge consists of a litter, placed horizontally, behind a caduceus with the cross of the Geneva Convention at the junction of the wings. Guidance for conducting the test was first published in Training Circular (TC) 8-100, in January 1988, and again in DA Pamphlet (pam) 40-20 in September 1999.

**1-3. PURPOSE.** This pam standardizes EFMB requirements and testing procedures. It provides DA criteria and administrative instructions concerning the award of the EFMB. This pam also governs the qualifications for the EFMB and prescribes new, standardized, written, and specific performance tests.

**1-4. APPLICABILITY.** This pam applies to all military personnel Armywide with an Army Medical Department (AMEDD) area of concentration (AOC) or military occupational specialty (MOS).

**1-5. REFERENCES.** Required and related publications and prescribed and referenced forms are listed in Appendix A.

**1-6. EXPLANATION OF ABBREVIATIONS AND TERMS.** Abbreviations and special terms used in this publication are explained in Appendix B.

**THIS PAGE LEFT INTENTIONALLY BLANK**

## CHAPTER 2

### ADMINISTRATIVE REQUIREMENTS

**2-1. THE EFMB.** The EFMB is a special skill badge authorized by Army Regulation (AR) 600-8-22. The EFMB—

- a. Recognizes qualified AMEDD personnel who demonstrate a high degree of professional skill, stamina, and proficiency.
- b. Recognizes medical personnel who can expertly—
  - (1) Perform combat medical tasks in a simulated combat environment.
  - (2) Perform common soldier tasks that support medical care in a simulated combat environment.
- c. Promotes esprit de corps. It provides an incentive for greater effort by AMEDD personnel and a badge of excellence that is recognized worldwide by the total Army.
- d. Provides quality training for AMEDD personnel.

### **2-2. ELIGIBILITY.**

a. The EFMB is awarded to DA personnel who meet the following requirements and pass the EFMB test in accordance with (IAW) Chapter 3. Other service and allied candidates must be either medical personnel or serving in comparable medical positions.

(1) Officers must be assigned or detailed to an AMEDD corps. This includes Army officers in training at the Uniformed Services University of the Health Sciences. It also includes Army officers enrolled in the Health Professions Scholarship Program.

(2) Warrant officers must have an AMEDD primary MOS controlled by The Surgeon General. Warrant officer pilots with a “D” special qualifications identifier (Aeromedical Evacuation Pilot) and assigned to an air ambulance unit are also eligible.

(3) Enlisted personnel must have an AMEDD primary MOS or MOS 18D. This includes all MOSs in the 91-career management field.

b. Candidates must—

- (1) Volunteer for EFMB testing.
- (2) Be recommended by their unit commander.
- (3) Be physically prepared to cope with the rigorous demands of the EFMB test and trained in the prevention of heat-related injuries.
- (4) Qualify as marksman or higher with their assigned weapon within 1 year of the test-end date.

(5) Score a minimum of 180 points on the Army Physical Fitness Test (APFT), with a minimum of 60 points in each event, within 6 months of the test-end date. Alternate events are not authorized. Soldiers with medical profiles prohibiting participation in any of the three events are ineligible to compete.

(6) Possess a current American Heart Association (AHA) cardiopulmonary resuscitation (CPR) certification. The certification must be valid through the test-end date.

(7) Other service and allied candidates must meet the Army's APFT and weapon standards.

(8) Perform all tasks professionally and ethically IAW this pam and the Army values.

### **2-3. PROVISIONS AND AUTHORITIES.**

a. The Surgeon General is the Army staff agent for the EFMB Program.

b. The Commandant, Academy of Health Sciences (AHS), is the executive agent for the management of the EFMB Program.

c. Commanders of the following types of units, in the grade of lieutenant colonel or above, are qualified to administer the EFMB test as a host unit:

(1) Active Army, U.S. Army Reserve, and Army National Guard table of organization and equipment and table of distribution and allowances medical units.

(2) Division support command commanders.

(3) Separate regiments and brigades having the resources and facilities to conduct all phases of the test as explained in this pam.

### **2-4. DUTIES.**

a. Commandant, AHS.

(1) Exercises approval authority as to who may administer the EFMB test and whether or not a particular program is approved.

(2) Standardizes the EFMB test Armywide.

(3) Develops and maintains the EFMB requirements.

(4) Selects test control officers (TCOs). The TCOs must hold the rank of sergeant first class (SFC) or higher and be an awardee of the EFMB.

(5) Funds trips for validation or standardization review visits.

(6) Selects host units for validation or standardization review. All units approved to administer the EFMB test are subject to a validation or standardization review.

(7) Grants exceptions to policy.

b. AHS EFMB TCO.

(1) As the representative of the Commandant, AHS, observes units selected for validation or standardization review to ensure that they comply with the standards in this pam.

(2) Coordinates with host units and provide EFMB test packets.

(3) Enforces the standards in this pam and reports deviations to the test board chairperson IAW paragraph 2-8.

(4) Submits a report of test deviation to the Commandant, AHS, in cases of unresolved test standard deficiencies.

(5) Maintains the EFMB website ([www.cs.amedd.army.mil/dts/efmbhome.htm](http://www.cs.amedd.army.mil/dts/efmbhome.htm)).

c. Host commander.

(1) Requests to conduct the EFMB (see paragraph 2-5).

(2) Appoints a field grade AMEDD officer as the test board chairperson. This individual is responsible for conducting the EFMB test IAW this pam and must be an awardee of the EFMB.

(3) Establishes an EFMB test board. The test board will consist of three or more AMEDD officers or noncommissioned officers in the rank of SFC or higher. Test board members must be awardees of the EFMB.

(4) Coordinates administrative, logistical, and medical support for the test.

(5) Assigns combat lane officer in charge (OIC) or noncommissioned officer in charge (NCOIC) who will be responsible for the operation of each of the lanes.

(6) Assigns evaluators who are subject matter experts in the tasks they will be grading. Non-AMEDD subject matter experts are recommended as evaluators for nonmedical tasks. At a minimum, the emergency medical treatment task evaluators must be awardees of the EFMB.

(7) Ensures that risk management requirements are planned and executed during EFMB training and testing IAW guidance from the Commandant, AHS, and Field Manual (FM) 100-14.

(8) Presents the EFMB in an appropriate awards ceremony (see paragraph 2-11).

d. Test board chairperson.

(1) Conducts a by-lane analysis of previous EFMB tests at the installation to identify weaknesses that require corrections or further candidate preparation. The TCO may assist the test board chairperson regarding Armywide issues and results. This will help to ensure a better training environment and utilization of training resources.

(2) Requests concept approval of lane setup, scenario, and tasks on each lane from the EFMB TCO not later than 60 days (180 days for U.S. Army Reserve and Army National Guard units) prior to the anticipated test-start date.

(3) Administers the EFMB test IAW the standards in this pam (see paragraphs 2-9 and 3-7).

(4) Receives and processes the written test (WT) packet from the EFMB TCO (see paragraph 2-6).

(5) Secures and safeguards the WT (see paragraph 2-7).

(6) Maintains a file for each candidate that includes a copy of the soldier's —

(a) Commander's recommendation.

(b) APFT scorecard.

(c) Weapons qualification (WQ) scorecard.

(d) AHA CPR certification card.

(7) Conducts evaluator and lane validations to include 12-mile foot march and land navigation courses prior to standardization and test weeks. Ensures that combat lanes are set up IAW paragraph 3-6.

(8) Ensures that at least two test board members are onsite during standardization and testing.

(9) Ensures that risk management requirements are planned and executed during EFMB standardization and testing.

(10) Chairs the EFMB rebuttal board (see paragraph 2-10).

(11) Removes candidates that compromise test integrity.

(12) Forwards a copy of orders on candidates awarded the EFMB, to the TCO, within 1 week after test-end date.

(13) Forwards the original candidate test results recorded on U.S. Army Medical Department Center and School (AMEDDC&S) Form 1232-R to the candidate's commander and retains a copy on file. (The AMEDDC&S Form 1232-R will be locally reproduced on 8 1/2 - by 11-inch paper. A copy for reproduction purposes is located at the back of this pam.)

(14) Submits an after action review to the Commandant, AHS, within 1 month after the test-end date IAW FM 25-101 and TC 25-20. Notable issues will be posted on the AMEDDC&S's Lessons Learned and EFMB websites for future testing improvements.

e. Test board members.

(1) Enforce the standards in this pam (see paragraphs 2-9 and 3-7).



(2) Assist test board chairperson in conducting evaluator and lane validations to include 12-mile foot march and land navigation courses prior to standardization and test weeks. Ensure that combat lanes are set up IAW paragraph 3-6.

(3) Participate in rebuttal board proceedings, ensuring fair adjudication based upon the task conditions and standards in this pam (see paragraph 2-10).

(4) Rotate among test areas to reinforce standardization and troubleshoot areas identified by reoccurring rebuttals.

(5) Administer the WT (see paragraphs 2-6 and 3-9).

f. Lane OICs/NCOICs.

(1) Enforce the standards in this pam (see paragraphs 2-9 and 3-7).

(2) Ensure that the lane is set up IAW paragraph 3-6. The test board chairperson will provide lane concept and flow.

(3) Ensure that evaluators and lanes are validated by the test board prior to standardization and test weeks.

(4) Require candidates to complete all tasks on a lane prior to informing them of the results.

(5) Ensure that all personnel, unit equipment, and supplies to run the lane are on hand.

(6) Attend rebuttal board proceedings when the board is considering a task for which a lane evaluator was responsible.

(7) Ensure that risk management requirements are planned and executed.

g. Evaluators.

(1) Evaluate all candidates IAW the standards in this pam (see paragraphs 2-9 and 3-7).

(2) Require candidates to complete all tasks on a lane prior to informing them of the results.

(3) Report candidate integrity violations to the lane OIC/NCOIC and test board chairperson.

(4) Attend rebuttal board proceedings when the board is considering a task for which the evaluator was responsible.

(5) Ensure that noncandidates/casualties have been briefed and validated on their responsibilities and perform their roles in a professional manner.

h. Unit commanders.

(1) Recommend only those candidates who volunteer for EFMB testing and meet the eligibility requirements in paragraph 2-2.

(2) Arrange for the APFT, WQ, and AHA CPR certification requirements and provide a copy of the results to the test board chairperson.

(3) Prepare a memorandum of recommendation/certification (see Figure 2-2).

(4) Conduct EFMB training and preparation in advance of the EFMB test.

(5) Provide candidates with a copy of this pam, references listed in paragraph 3-9e, and training material for preparation of testing.

(6) Ensure that candidates are physically prepared to cope with the rigorous demands of the EFMB test. Candidates must have been trained in the prevention of heat-related injuries IAW the U.S. Army Center for Health Promotion and Preventive Medicine (<http://chppm-www.apgea.army.mil/heat/>) as well as the 12-mile foot march IAW FM 21-18.

## **2-5. REQUESTING TO CONDUCT THE EFMB TEST.**

a. To host an EFMB test, the unit must have a minimum of 50 eligible candidates. Commanders not having 50 eligible candidates are encouraged to consolidate testing with organizations on the same or adjacent installations. However, units in remote locations having fewer than 50 eligible candidates may request an exception to policy.

b. The EFMB test requires a large commitment of equipment and personnel; therefore, every effort should be made to conserve resources and allow maximum participation of qualified personnel.

c. The host commander submits a request to administer the EFMB test and receive test materials to the Academy of Health Sciences, ATTN: MCCS-HTU, 1750 Greeley Road, Suite 135, Fort Sam Houston, TX 78234-5078, not later than 120 days (210 days for U.S. Army Reserve and Army National Guard units) prior to the anticipated test-start date. Figure 2-1 is an example of the request memorandum. The request must be submitted in this format.

## **2-6. WRITTEN TEST MATERIALS.**

a. Upon approval to host the EFMB, the TCO will forward a WT packet, consisting of one copy of the following, to the test board chairperson not later than 30 days prior to the test-start date:

(1) WT.

(2) WT reference key.

(3) Punch-out answer key.

(4) Answer sheet.

- (5) Statement of receipt.
- (6) Statement of verification.
- (7) Statement of destruction.
- (8) Test memorandum.
- (9) Changes or additions to EFMB tasks tested.
- (10) Test questionnaire.

b. Upon receipt, the test board chairperson inventories the contents of the WT packet. He or she completes the statement of receipt and returns it to the TCO within 4 days.

c. The test board chairperson secures the WT and related documents IAW paragraph 2-7.

d. A test board member must take the test prior to its administration to the candidates. At no time should the test board withdraw questions from the WT without approval from the TCO.

e. A test board member reproduces one copy of the WT and answer sheet for each candidate.

f. Within 2 days of completing the WT, the test board chairperson personally supervises the destruction of the original and all copies of the WT and answer key. He or she then signs the statement of destruction and returns it to the TCO within 1 week after destruction is accomplished.

g. Unit or individual file copies of the WT and answer keys are not authorized.

h. Within 1 week of the test-end date, the test board chairperson forwards the candidates' completed test-answer sheets and test questionnaires to the TCO. The TCO uses this information to compile Armywide statistical data for use in test analysis.

## **2-7. SECURITY OF WRITTEN TEST MATERIALS.**

a. The test board chairperson is responsible for securing WT materials. Functions required in establishing and maintaining test security may be delegated to a test board member. Security measures are established by all elements where EFMB test materials are handled, administered, or stored. Security procedures must ensure close supervision of all phases of test receipt, storage, security, duplication, issue, administration, scoring, and destruction.

b. When not in transit or actual use, test materials are stored in a locked room or container, accessible only to authorized individuals. Only persons whose duties require access to test materials have keys and combinations to storage facilities. Test-scoring keys are not stored with the test booklets and blank answer sheets.

c. Security requirements established in this pam meet the requirements of "FOR OFFICIAL USE ONLY" material IAW AR 25-55. These materials bear the designation "FOR OFFICIAL USE ONLY." The only exception to this is the blank answer sheet.

**2-8. VALIDATION/STANDARDIZATION REVIEW.** The TCO is responsible for ensuring that the host unit conducts the EFMB test IAW the standards in this pam. Units approved to conduct the EFMB test are subject to a validation or standardization review. Upon arrival, the TCO identifies himself or herself to the test board chairperson. The TCO validates the host unit by observing some or all aspects of the test and will not interfere with standardization or testing unless a deviation is observed. The TCO reports deviations to the test board chairperson for correction. If necessary, the TCO may halt standardization or testing until the deviation is resolved.

**2-9. EXCEPTION TO POLICY.** Every effort will be made to preserve test integrity and continuity. Exception to policy requests concerning test content should be carefully scrutinized prior to submission. The request must be submitted to the Commandant, AHS, not later than 45 days (180 days for U.S. Army Reserve and Army National Guard units) prior to the anticipated test-start date. Send requests to the address in paragraph 2-5c.

**2-10. REBUTTAL/APPEAL PROCEDURES.**

a. Rebuttal. During the test period, the test board chairperson conducts a rebuttal board daily. A minimum of three test board members vote. Candidates must be given the opportunity to appear before the board to present verbally, or in writing, their reasons for the rebuttal. Evaluators will appear before the board to support their position. The decision of the test board is final. Test board members will —

(1) Review the standards in this pam for each disputed task prior to voting. No other references are required.

(2) Adjudicate based upon the task conditions and standards in this pam.

b. Appeal. The candidate has the right to appeal the test board's rebuttal decision on the WT event only to the Commandant, AHS. The appeal must be submitted through the host unit and the EFMB TCO to the Commandant, AHS, not later than 15 days after completion of the EFMB test.

**2-11. AWARDING THE EFMB.**

a. The EFMB is presented at an appropriate awards ceremony and worn IAW AR 670-1.

b. Award of the EFMB is announced in orders, citing AR 600-8-22 as authorization. Copies are forwarded to the military personnel officer for entry into the awardees' official records. Copies are also forwarded to the TCO and the awardee.

c. A certificate of training may be awarded to candidates who completed all EFMB test requirements, but failed to receive a passing score. The test board chairperson will determine the number of training hours to be awarded to these soldiers.

d. A unit is awarded an Expert Medical Streamer IAW AR 600-8-22.



REPLY TO  
ATTENTION OF

**DEPARTMENT OF THE ARMY**  
ORGANIZATIONAL NAME/TITLE  
STANDARDIZED STREET ADDRESS  
CITY, STATE, AND ZIP + 4 CODE

OFFICE SYMBOL

Date

MEMORANDUM FOR Academy of Health Sciences (MCCS-HTU), 1750 Greeley Road, Suite 135, Fort Sam Houston, TX 78234-5078

SUBJECT: Request for Expert Field Medical Badge (EFMB) Test Site Approval and Test Materials

1. Reference US Army Medical Department Center and School Pamphlet 350-10, Expert Field Medical Badge (EFMB) Test.
2. We have the personnel and logistical resources to conduct all aspects of the EFMB test and would like your approval to administer the EFMB test as the host unit in accordance with the above reference, paragraph 2-5.
3. The following information is provided:
  - a. Validation dates:
  - b. Standardization dates:
  - c. Test dates:
  - d. Location of field test site:
  - e. Number of soldiers scheduled to take the test:
  - f. EFMB test board chairperson:  
Rank, name:  
Address (include street address, building number, and room number):  
Telephone number and FAX (DSN and commercial):  
E-mail address:
  - g. Officer/NCO in charge:  
Rank, name:  
Telephone number and FAX (DSN and commercial):  
E-mail address:
4. This headquarters will provide security for the written test IAW AMEDDC&S Pam 350-10, paragraph 2-7.
5. Point of contact for this action is CPT Harris at (DSN and commercial).

JOHN Q. SMITH  
Lieutenant Colonel, MS  
Commanding



Figure 2-1. Request for EFMB Test Site Approval and Test Materials.



REPLY TO  
ATTENTION OF

**DEPARTMENT OF THE ARMY**  
**ORGANIZATIONAL NAME/TITLE**  
**STANDARDIZED STREET ADDRESS**  
**CITY, STATE, AND ZIP + 4 CODE**

OFFICE SYMBOL

Date

MEMORANDUM FOR EFMB Test Board Chairperson, Host Unit

SUBJECT: Expert Field Medical Badge (EFMB) Test Candidate  
 Recommendation/Certification

1. Reference US Army Medical Department Center and School Pamphlet 350-10, Expert Field Medical Badge (EFMB) Test.

2. I recommend the following candidates for EFMB testing, acknowledging that training and fitness of soldiers are a commander's responsibility. All candidates have volunteered for testing. They have completed the Army Physical Fitness Test (APFT) and weapons qualification (WQ), and are American Heart Association cardiopulmonary resuscitation (CPR) certified. I further certify that they have been provided all necessary training materials, including the prevention of heat-related injuries, and are physically fit to cope with the rigorous demands of the EFMB test.

RANK, NAME, AND SSN	MOS/ AOC	WQ DATE SCORE	APFT DATE SCORE	CPR CERT DATE	FITNESS/ HEAT PREV TNG
CPT Smith, Rob XXX-XX-XXXX	70H	9 Nov 02 Expert	15 Nov 02 250	7 Feb 03	Yes
SFC Jones, Mark XXX-XX-XXXX	91W	10 Nov 02 Sharpshooter	15 Nov 02 275	7 Feb 03	Yes
SPC Santos, Jose XXX-XX-XXXX	91J	9 Nov 02 Expert	15 Nov 02 300	19 Feb 03	Yes

3. Point of contact for memorandum is the undersigned at (DSN and commercial).

THOMAS A. JONES  
 Captain, MS  
 Commanding



Figure 2-2. Commander's Recommendation/Certification Memorandum.

## CHAPTER 3

### CONDUCT OF THE EFMB TEST

**3-1. REQUIREMENTS.** To qualify for the EFMB, candidates must have successfully completed the eligibility requirements in paragraph 2-2. In addition, they must successfully complete the required number of tasks in each of the eight critical performance areas in paragraphs 3-9 through 3-16.

### 3-2. CLARIFICATION OF PERFORMANCE MEASURES.

#### NOTE

Some of the tasks in this pam were obtained from Soldier Training Publications (STP) and revised to meet EFMB requirements. The performance conditions, standards, steps, and measures in this pam are for EFMB TESTING PURPOSES ONLY.

a. Some tasks and performance measures have time standards. These time standards are for test administering purposes only.

b. Test board members, evaluators, and candidates must ensure that they are using the most current EFMB material. The TCO furnishes changes to tasks, conditions, and standards to the test board prior to training or testing. Changes are also posted on the EFMB website ([www.cs.amedd.army.mil/dts/efmbhome.htm](http://www.cs.amedd.army.mil/dts/efmbhome.htm)).

### 3-3. TEST PERIOD.

a. The EFMB test is designed to be both physically and mentally challenging. The test, to include the written portion, is conducted in 5 consecutive days (120 hours). If additional time is needed, the host unit commander will request an exception to policy IAW paragraph 2-9.

b. All performance testing is conducted in a field environment. The WT, however, may be administered in a garrison environment. Candidates must bivouac in tents during the entire test period.

c. Testing must be conducted IAW this pam.

d. U.S. Army Reserve and Army National Guard units will conduct EFMB testing during annual training periods.

### 3-4. TRAINING.

a. Training prior to the test period is the responsibility of the candidate's chain of command.

b. Inconsistencies in, or improper unit training prior to the test period are not grounds for rebuttal.

c. If the host unit elects to conduct a standardization week prior to testing, it is imperative that the test board chairperson accomplishes validation requirements prior to standardization week.

### **3-5. EQUIPMENT.**

a. Candidates are required to carry all of the equipment in Table 3-1, to include the rucksack, to the start point of all lanes, but not during the testing of tasks. The ballistic helmet, load-carrying equipment (LCE), protective mask, and the M16/M4-series rifle will be carried at all times. The test board chairperson will determine which lanes he or she wishes to be negotiated with rucksack worn, except as follows:

(1) The rucksack is not carried or worn on the litter obstacle course (LOC) and land navigation course.

(2) The rucksack must be carried or worn on the 12-mile foot march IAW Table 3-1 and paragraph 3-16.

b. During the WT, the candidates may wear the battle dress uniform (BDU). The field uniform is not required for this task.

c. The M16/M4-series rifle will be carried, worn, or within an arm's reach (one meter from the candidate's position) at all times. The candidate may receive an administrative NO GO on any tasks in which the weapon is not within an arm's reach.

d. Rubber weapons will NOT be used in any portion of the EFMB test.

### **3-6. BATTLEFIELD SCENARIO AND COMBAT LANE CONCEPTS.**

a. Battlefield scenarios.

(1) The creation of simulated combat conditions is critical to the evaluation of performance-oriented testing. Pyrotechnics, smoke, opposing force activity, realistic moulage, and anatomic simulators are used extensively to enhance realistic conditions.

(2) Table 3-2 is a recommended list of pyrotechnics for a test cycle of approximately 500 candidates.

b. Combat lanes.

(1) Candidates are tested on each task as outlined in this pam. Combat lanes will include mission-related tasks using reaction-style testing. Common task training, station, and round-robin style testing will not be used at any time.

(2) Tasks from the critical performance areas of communications, common skills, and evacuation may be integrated with each other. These tasks may also be integrated before or after, but not during, the emergency medical treatment and LOC events. The test board chairperson will determine sequencing of the tasks on all combat lanes, ensuring a logical flow of events.

(3) Candidates are given blank rounds to fill a minimum of one magazine before the start of each lane that has opposing force activity.



(4) Candidates are given a written or verbal operation order (OPORD), fragmentary order (FRAGO), or scenario brief before the start of each lane and not during testing of the tasks. See FM 101-5 for a sample OPORD or FRAGO.

(5) After a candidate starts a lane, his or her interactions with the evaluator must be minimized.

(6) Introduction sections of each critical performance area provide further guidance on combat lane setup requirements.

c. Exceptions. The land navigation, 12-mile foot march, and WT events will not be in a battlefield scenario or combat lane setup.

### **3-7. PERFORMANCE STANDARDS.**

a. The figures in this chapter list the performance standards for each task. They are provided as formats to be used by the evaluators. Candidates may use them in preparing for hands-on task testing. Evaluators will record the completed hands-on test results on AMEDDC&S Form 1232-R.

b. In some cases, there are different figures provided for the same tasks. The different figures are included to illustrate the difference in standards and performance measures between the different types of equipment.

c. The figures ensure that every candidate is graded by the same standards. At no time will evaluators deviate from the standards in the figures. Candidates performing steps not listed in the figures will not be penalized as long as they perform all required performance steps for each performance measure in the allotted time, if applicable.

d. Candidates may receive an administrative NO GO for test integrity violations on any tested task even though it is not stated as a performance step or measure. Candidates may also receive an administrative NO GO for weapons violations IAW paragraph 3-5c.

**3-8. CHANGES.** Changes to the tasks in this pam require an exception to policy IAW paragraph 2-9.

**3-9. WRITTEN TEST.** Candidates must pass a WT consisting of 100 questions. Two hours are allowed for administering the WT. To pass, candidates must correctly answer a minimum of 75 questions.

a. The test board will administer the WT and cannot delegate this responsibility to a person who is not on the test board.

b. The test board will provide the candidate one pencil, one sheet of scratch paper, a copy of the WT, and one answer sheet to conduct the WT. Upon completion of the WT, candidates must return all materials to the test board. Candidates will initially receive a GO or NO GO by the test board. Test questions will not be reviewed with the candidates. The test scores will be forwarded to each candidate's unit commander, on AMEDDC&S Form 1232-R, upon completion of the EFMB test period.

c. The following references are used to derive the WT questions:

(1) FM 8-10-6, Medical Evacuation in a Theater of Operations Tactics, Techniques, and Procedures.

(2) FM 21-10, Field Hygiene and Sanitation.

(3) STP 8-91W15-SM-TG, Soldier's Manual and Trainer's Guide, MOS 91W, Health Care Specialist, Skill Levels 1/2/3/4/5 (skill level 1 tasks ONLY).

d. Changes are NOT authorized without an exception to policy approval.

**Table 3-1. Required equipment.**

Item	Quantity	Item	Quantity
<b><u>Worn</u></b>		<b><u>Carried: (continued)</u></b>	
Battle Dress Uniform	1 set	Pencil, Mechanical	1
Boots, Combat	1 pair	Rucksack with Frame	1
Helmet, Ballistic with Cover	1	Stick, Camouflage or Equivalent	1
Socks	1 pair	Suspenders, Individual Equipment	1
Tags, Identification	1 set		
T-shirt, Brown	1	<b><u>Placed in Rucksack</u></b>	
Underwear	1 pair	Bag, Waterproof	1
Watch	1	Boots, Combat	1 pair
<b><u>Carried</u></b>		Gloves, NBC Rubber	1 pair
Belt, Individual	1	Jacket, Chemical Protective	1
Canteen Water Plastic	2	Light stick, Chemical (Green or Yellow)	1
Card, Identification	1	Liner, NBC Gloves	1 pair
Case, First Aid	1	Overshoes, Rubber	1 pair
Case, Small Arms	2	Parka, Wet Weather	1
Compass, Lensatic	1	Poncho	1
Cover, Canteen	2	Protractor	1
Cup, Canteen Water	2	Socks	1 pair
Flashlight with Red and Green or Blue Lens	1	Trousers, Chemical Protective	1
Kit, M291 Skin Decon	2 kits	Trousers, Wet Weather	1
Mask, Protective with Carrier	1	T-Shirt, Brown	1
M16/M4-Series Rifle with Sling, (2) Magazines, and Blank Adapter	1	Underwear	1 pair
Notepad	1	Uniform, Battle Dress	1 set
Paper, M8	1 bk		
Pen	1		
<p><b>NOTE 1:</b> The terms rucksack, light fighter pack, and ALICE pack may be used interchangeably. Current issued Table of Allowance-50 may be used in lieu of rucksack and LCE.</p> <p><b>NOTE 2:</b> The protective mask, with carrier, and load-bearing vest/equipment are carried on the person as outlined in Technical Manual (TM) 3-4240-300-10-2.</p> <p><b>NOTE 3:</b> The M8 paper and M291 Skin Decon Kit are no longer required after the applicable nuclear, biological, and chemical (NBC) tasks are tested.</p>			

**Table 3-2. Recommended basic load of pyrotechnics for 500 candidates.**

Nomenclature	Amount
Cartridge, 5.56 mm, blank, M16	40,000
Grenade, smoke, green	900
Grenade, smoke, yellow	900
Grenade, smoke, violet	700
Simulator, grenade, hand	800

**THIS PAGE LEFT INTENTIONALLY BLANK**

### 3-10. LAND NAVIGATION TASKS.

a. Objective. The objective of the land navigation courses is to measure the candidate's ability to navigate from a start point, through intermediate points, to an end point during daylight and darkness.

b. Requirements. The candidate must successfully complete the performance measures for both the day and night courses to receive a GO. The tasks listed in paragraph 3-10c, below, are tested in a field environment with the required equipment IAW paragraph 3-5.

(1) Each point will be marked with a sign. The sign will —

(a) Be constructed of metal or wood.

(b) Measure 12 inches by 12 inches (30.4 by 30.4 centimeters).

(c) Be painted diagonally half-white and half-international orange.

(d) Be staked into the ground so that its bottom is between 5- and 7-feet (1.52 and 2.13 meters) above the ground. It WILL NOT BE mounted on vegetation.

(e) Have a clearly identifiable, unique letter or number on it for identification. Other markings (grid coordinates, azimuths, directions) are NOT authorized.

(2) The host unit will use a satellite-type navigational system to verify the points on the course.

(3) The host unit will not use preestablished points and score sheets from previous EFMB tests. A minimum of five start points and end points will be set up.

(4) The host unit will run standardization week the same as test week. Candidates, without assistance, will be allowed one opportunity to complete the day and night courses during standardization week.

(5) The host unit will place observers on the course to enforce land navigation standards.

(6) The host unit will not review the points with the candidates upon completion of both the day and night courses during standardization and test weeks. Candidates will receive a GO or NO GO.

(7) Candidates will carry a red-lens flashlight and a chemical light stick during the night course. The use of white light or a chemical light stick is for emergencies only.

(8) Prior to testing, candidates will be briefed on their responsibility to provide first aid to other candidates if the need arises. Candidates are not penalized for providing assistance. They will be allowed to retake the test without penalty if they should fail as a result of rendering aid.

(9) Candidates will be checked by host units for unauthorized test aids before and after the start of both the day and night courses.

(10) Candidates, without assistance, must negotiate each course within the time specified in the respective standard. They will NOT be penalized for the time it takes to move from the end point to the score sheet collection point. Evaluators must be present at the end points to annotate the candidate's end time.

c. Tasks.

(1) Day course. The day course must measure between 3,500 and 4,000 meters. The course has three direction changes, the first at point one (not the start point). No point on the course, to include distractor points, will be closer than 100 meters to another point. Candidates must navigate the course IAW the task standards.

(2) Night course.

(a) The night course must measure between 3,000 and 3,500 meters. The course has three direction changes, the first at point one (not the start point). No point on the course, to include distractor points, will be closer than 100 meters to another point. Candidates must navigate the course IAW the task standards.

(b) Artificial illumination (such as light sticks) may be used to mark the general boundaries of the course, but not the individual points. Candidates may not use artificial illumination or red-lens flashlight to mark their direction.

(c) The host unit may start the night course no earlier than 1 hour after sunset. The test board chairperson will determine the actual start time based on local conditions.

d. Equipment. The equipment required for the day and night courses is specified in Figures 3-1 and 3-2. **NO OTHER EQUIPMENT IS AUTHORIZED.** The host unit will issue the topographic map, score sheet, and the eight digit coordinates of the five points to the candidates for both the day and night courses. The map and score sheet must be returned to the host unit upon completion of each course.

e. Changes. Changes are NOT authorized without an exception to policy approval.

---

**NAVIGATE FROM ONE POINT TO ANOTHER DURING THE DAY**

**CONDITIONS:** Given a standard topographic map, scale 1:50,000; a lensatic compass; Graphic Training Aid (GTA) 05-02-012 (coordinate scale and protractor); a pencil; a score sheet; and the eight digit grid coordinates of the start point, three intermediate points, and end point.

**STANDARDS:** Plot the start point, intermediate points, and the end point on the map. Navigate from the start point, through each intermediate point, in order, to the end point, within 3 hours.

**PERFORMANCE STEPS:**

1. Plot all five points on the map.
2. Navigate from the start point, through the intermediate points, to the end point.

**PERFORMANCE MEASURES:**

	<b>GO</b>	<b>NO GO</b>
1. Navigated from the start point, through the intermediate points, in order, to the end point.	_____	_____
2. Correctly recorded the point number or letter of at least three points, excluding the start point.	_____	_____
3. Completed all performance measures within 3 hours.	_____	_____
4. Returned the map and score sheet.	_____	_____

**REFERENCES:**

**Required**

**Related**  
FM 3-25.26

---

Figure 3-1. Navigate From One Point to Another During the Day.

---

**NAVIGATE FROM ONE POINT TO ANOTHER DURING THE NIGHT**

**CONDITIONS:** Given a standard topographic map, scale 1:50,000; a lensatic compass; GTA 05-02-012 (coordinate scale and protractor); a pencil; a score sheet; a red-lens flashlight; a chemical light stick for emergency use; and the eight digit grid coordinates of the start point, three intermediate points, and end point.

**STANDARDS:** Plot the start point, intermediate points, and the end point on the map. Navigate from the start point, through each intermediate point, in order, to the end point, within 4 hours.

**PERFORMANCE STEPS:**

1. Plot all five points on the map.
2. Navigate from the start point, through the intermediate points, to the end point.

**PERFORMANCE MEASURES:**

	<b>GO</b>	<b>NO GO</b>
1. Navigated from the start point, through the intermediate points, in order, to the end point.	_____	_____
2. Correctly recorded the point number or letter of at least three points, excluding the start point.	_____	_____
3. Did not mark the route of travel with the red-lens flashlight.	_____	_____
4. Completed all performance measures within 4 hours.	_____	_____
5. Returned the map and score sheet.	_____	_____

**REFERENCES:**

**Required**

**Related**  
FM 3-25.26

---

Figure 3-2. Navigate From One Point to Another During the Night.



### 3-11. COMMUNICATION TASKS.

a. Objective. The objective of the communication tasks is to measure the candidate's ability to install, initiate, and operate field communications equipment and use correct communications procedures in a battlefield scenario.

b. Requirements. The candidate is required to complete the performance measures in the four performance tasks listed in paragraph 3-11c, below, and receive a GO in three of the four. All tasks will be tested in a battlefield scenario with the required equipment IAW paragraphs 3-5 and 3-6.

(1) The host unit will provide the candidates information required to conduct the communications tasks (e.g., call signs, frequency, medical evacuation (MEDEVAC) request) during the OPORD, FRAGO, or scenario brief.

(2) The host unit will issue the candidate one GTA 03-06-008 (NBC Warning and Reporting System), one GTA 08-01-004 (MEDEVAC Request Form), and one NBC 1 report map before the start of the combat lane that requires them. Candidates may not use their own GTA cards.

(3) Candidates will not be allowed to use the issued GTA cards, NBC 1 report map, or information provided in the OPORD, FRAGO, or scenario brief until the task is tested.

(4) Candidates' notepads will not be used to prescript communications tasks prior to testing of the task.

(5) Evaluators will report all test integrity violations to the lane OIC or NCOIC and the test board.

c. Tasks. Candidates will be tested on one task from each area below. The test board chairperson will determine which tasks are tested prior to the test-start date. All candidates will be tested on the same task, using the same equipment.

(1) Radio.

(a) Assemble and operate a single channel ground and airborne radio system (SINCGARS) (Advanced System Improvement Program [ASIP]) without automated net control device (ANCD) (Figure 3-3).

(b) Assemble and operate a SINCGARS without the ANCD (Figure 3-4).

(2) Radio net.

(a) Load frequency hop (FH)/communications security (COMSEC) data and conduct radio check using SINCGARS (ASIP) (Figure 3-5).

(b) Load FH/COMSEC data and conduct radio check using SINCGARS (Figure 3-6).

(3) Prepare and transmit a MEDEVAC request (using secure mode radio) (Figure 3-7).

(4) Submit NBC 1 report (Figure 3-8).

d. Equipment. Some of the communications tasks offer a choice of equipment. The test board chairperson selects the equipment. At no time will the equipment for tasks not selected be at the test site.

e. Changes. Changes are NOT authorized without an exception to policy approval.

---

**ASSEMBLE AND OPERATE A SINCGARS (ASIP) WITHOUT ANCD**

**CONDITIONS:** Given a SINCGARS radio (AN/PRC-119E/F), handset, antenna base, whip antenna, a battery, an operating frequency, a call sign, and the receiving station's call sign.

**STANDARDS:** Assemble the radio, set the operating frequency for single channel unsecured operation, and perform a radio check within 5 minutes.

**PERFORMANCE STEPS:**

1. Install battery.
2. Screw whip antenna into antenna base, hand tight.
3. Screw antenna base into "RT ANT" connector, hand tight.
4. Connect handset connector to "AUD/DATA" connector.
5. Set "MODE" to "SC" via "MENU" key.
6. Set "FCTN" to "TST," should read "GOOD."
7. Set "CHAN" to desired channel via "MENU" key.
8. Press "FREQ," then "CLR" on the keypad.
9. Enter the frequency given and press "STO" on the keypad
10. Set "RF PWR" to desired setting ("LO," "M," "HI") via "MENU" key.
11. Set "FCTN" to "SQ ON."
12. Perform a radio check using correct radio procedure and prowords.

**PERFORMANCE MEASURES:**

	<b>GO</b>	<b>NO GO</b>
1. Installed battery.	_____	_____
2. Screwed whip antenna into antenna base, hand tight.	_____	_____
3. Screwed antenna base into "RT ANT" connector, hand tight.	_____	_____
4. Connected handset connector to "AUD/DATA" connector.	_____	_____
5. Set "MODE" to "SC" via "MENU" key.	_____	_____
6. Set "FCTN" to "TST," should read "GOOD."	_____	_____
7. Set "CHAN" to desired channel via "MENU" key.	_____	_____
8. Pressed "FREQ," then "CLR" on the keypad.	_____	_____
9. Entered the frequency given and pressed "STO" on the keypad.	_____	_____
10. Set "RF PWR" to desired setting ("LO," "M," "HI") via "MENU" key.	_____	_____
11. Set "FCTN" to "SQ ON."	_____	_____
12. Performed a radio check using correct radio procedure/prowords.	_____	_____
13. Completed all performance measures within 5 minutes.	_____	_____

**REFERENCES:**

**Required**

**Related**

TM 11-5820-890-10-8

---

Figure 3-3. Assemble and Operate a SINCGARS (ASIP) Without ANCD.

---

**ASSEMBLE AND OPERATE A SINGGARS WITHOUT THE ANCD**

**CONDITIONS:** Given a SINGGARS radio (AN/PRC-119A/B), handset, antenna base, whip antenna, a battery, an operating frequency, a call sign, and the receiving station's call sign.

**STANDARDS:** Assemble the radio, set the operating frequency for single channel unsecured operation, and perform a radio check within 5 minutes.

**PERFORMANCE STEPS:**

1. Install battery.
2. Screw whip antenna into antenna base, hand tight.
3. Screw antenna base into "RT ANT" connector, hand tight.
4. Connect handset connector to "AUD/DATA" connector.
5. Set "MODE" to "SC," "CHAN" to position "1," "COMSEC" to "PT," and "PWR" to desired setting.
6. Set "FCTN" to "TST," should read "GOOD."
7. Set "FCTN" to "LD."
8. Press "FREQ," then "CLR" on the keypad.
9. Enter the given frequency and press "STO" on the keypad.
10. Set the "FCTN" to "SQ ON."
11. Perform a radio check using correct radio procedure and prowords.

**PERFORMANCE MEASURES:**

	<b>GO</b>	<b>NO GO</b>
1. Installed battery.	_____	_____
2. Screwed whip antenna into antenna base, hand tight.	_____	_____
3. Screwed antenna base into "RT ANT" connector, hand tight.	_____	_____
4. Connected handset connector to "AUD/DATA" connector.	_____	_____
5. Set "MODE" to "SC," "CHAN" to position "1," "COMSEC" to "PT," and "PWR" to desired setting.	_____	_____
6. Set "FCTN" to "TST," should read "GOOD."	_____	_____
7. Set "FCTN" to "LD."	_____	_____
8. Pressed "FREQ," then "CLR" on the keypad.	_____	_____
9. Entered the given frequency and pressed "STO" on the keypad.	_____	_____
10. Set the "FCTN" to "SQ ON."	_____	_____
11. Performed a radio check using correct radio procedure/prowords.	_____	_____
12. Completed all performance measures within 5 minutes.	_____	_____

**REFERENCES:**

**Required**

**Related**

TM 11-5820-890-10-8

---

Figure 3-4. Assemble and Operate a SINGGARS Without the ANCD.

**LOAD FH/COMSEC DATA AND CONDUCT RADIO CHECK USING  
SINGGARS (ASIP)**

**CONDITIONS:** Given a SINGGARS radio (AN/PRC-119E/F) with components, a battery, an ANCD (AN/CYZ-10) loaded with signal operation instructions (SOI) and FH/COMSEC data and a W-4 cable, an operating frequency, a call sign, and the receiving station's call sign.

**STANDARDS:** Load radio for single channel secure operations and complete a radio check within 10 minutes.

**PERFORMANCE STEPS:**

1. Set "FCTN" to "TST." Wait for "GOOD" on display.
2. Set "FCTN" to "LD."

**NOTE:** Steps 1 and 2 may be skipped if this task is performed after "Assemble and Operate a SINGGARS (ASIP) Without ANCD" task.

3. Set "COMSEC" to "CT" via "MENU" key.
4. Set "MODE" to "FH" via "MENU" key.
5. Press handset twice to clear audio alarm in handset to solid tone.
6. Turn "ANCD" on and enter "RADIO" at the main menu.
7. Press "Enter" for "Send-Radio-Icom" at next three screens.
8. Follow guidance for next two steps by down arrow.
9. Enter "Y" at the menu (time), then press "LOAD" on the "RT."
10. Set "CHAN" to desired channel via "MENU" key.
11. Press "FREQ," then "CLR" on the keypad.
12. Enter the frequency given and press "STO" on the keypad.
13. Set "RF PWR" to desired setting ("LO", "M", "HI").
14. Set "FCTN" to "SQ ON."
15. Conduct radio check using proper procedures and prowords.

**PERFORMANCE MEASURES:**

**GO      NO  
GO**

1. Set "FCTN" to "TST." Waited for "GOOD" on display.	_____	_____
2. Set "FCTN" to "LD."	_____	_____
3. Set "COMSEC" to "CT" via "MENU" key.	_____	_____
4. Set "MODE" to "FH" via "MENU" key.	_____	_____
5. Pressed handset twice to clear audio alarm in handset to solid tone.	_____	_____
6. Turned ANCD on and entered "RADIO" at the main menu.	_____	_____
7. Pressed "Enter" for "Send-Radio-Icom" at next three screens.	_____	_____
8. Followed guidance for next two steps by down arrow.	_____	_____
9. Entered "Y" at the menu (time), then pressed "LOAD" on the "RT."	_____	_____
10. Set "CHAN" to desired channel via "MENU" key.	_____	_____
11. Pressed "FREQ," then "CLR" on the keypad.	_____	_____
12. Entered the frequency given and pressed "STO" on the keypad.	_____	_____

**PERFORMANCE MEASURES:**

**GO**      **NO  
GO**

- |   |       |       |
|---|-------|-------|
| 13. Set "RF PWR" to desired setting ("LO", "M", "HI").              | _____ | _____ |
| 14. Set "FCTN" to "SQ ON."  | _____ | _____ |
| 15. Performed a radio check using correct radio procedure/prowords. | _____ | _____ |
| 16. Completed all required performance measures within 10 minutes.  | _____ | _____ |

**REFERENCES:**

**Required**

**Related**

TM 11-5820-890-10-8

TB 11-5820-890-12

---

Figure 3-5. Load FH/COMSEC Data and Conduct Radio Check  
Using SINCGARS (ASIP).

**LOAD FH/COMSEC DATA AND CONDUCT RADIO CHECK USING SINGARS**

**CONDITIONS:** Given a SINGARS radio (AN/PRC-119A/B) with components, a battery, an ANCD (AN/CYZ-10) loaded with SOI and FH/COMSEC data and a W-4 cable, an operating frequency, a call sign, and the receiving station's call sign.

**STANDARDS:** Load radio for single channel secure operations and complete a radio check within 10 minutes.

**PERFORMANCE STEPS:**

1. Set "FCTN" to "TST." Wait for "GOOD" on display.
2. Set "FCTN" to "LD."

**NOTE:** Steps 1 and 2 may be skipped if this task is performed after "Assemble and Operate a SINGARS Without the ANCD" task.

3. Set "COMSEC" to "CT."
4. Set "MODE" to "FH."
5. Press handset twice to clear audio alarm in handset to solid tone.
6. Turn ANCD on and enter "RADIO" at the main menu.
7. Press "Enter" for "Send-Radio-Icom" at next three screens.
8. Follow guidance for next two steps by down arrow.
9. Enter "Y" at the menu (time), then press "LOAD" on the "RT."
10. Set "CHAN" to desired position.
11. Press "FREQ," then "CLR" on the keypad.
12. Enter the frequency given and press "STO" on the keypad.
13. Set "RF PWR" to desired setting ("LO", "M", "HI").
14. Set "FCTN" to "SQ ON."
15. Conduct radio check using proper procedures and prowords.

**PERFORMANCE MEASURES:**

**GO**      **NO  
GO**

- |   |       |       |
|---|-------|-------|
| 1. Set "FCTN" to "TST." Waited for "GOOD" on display.                   | _____ | _____ |
| 2. Set "FCTN" to "LD."  | _____ | _____ |
| 3. Set "COMSEC" to "CT."  | _____ | _____ |
| 4. Set "MODE" to "FH."  | _____ | _____ |
| 5. Pressed handset twice to clear audio alarm in handset to solid tone. | _____ | _____ |
| 6. Turned ANCD on and entered "RADIO" at the main menu.                 | _____ | _____ |
| 7. Pressed "Enter" for "Send-Radio-Icom" at next three screens.         | _____ | _____ |
| 8. Followed guidance for next two steps by down arrow.                  | _____ | _____ |
| 9. Entered "Y" at the menu (time), then pressed "Load" on the "RT."     | _____ | _____ |
| 10. Set "CHAN" to desired position.                                     | _____ | _____ |
| 11. Pressed "FREQ," then "CLR" on the keypad.                           | _____ | _____ |
| 12. Entered the frequency given and pressed "STO" on the keypad.        | _____ | _____ |
| 13. Set "RF PWR" to desired setting ("LO", "M", "HI").                  | _____ | _____ |

**PERFORMANCE MEASURES:**

**GO**      **NO  
GO**

- |   |       |       |
|---|-------|-------|
| 14. Set "FCTN" to "SQ ON."  | _____ | _____ |
| 15. Performed a radio check using correct radio procedure/prowords. | _____ | _____ |
| 16. Completed all required performance measures within 10 minutes.  | _____ | _____ |

**REFERENCES:**

**Required**

**Related**

TM 11-5820-890-10-8

TB 11-5820-890-12

---

Figure 3-6. Load FH/COMSEC Data and Conduct Radio Check Using SINCGARS.



---

**PREPARE AND TRANSMIT A MEDEVAC REQUEST  
(USING SECURE MODE RADIO)**

**CONDITIONS:** Given three or four treated casualties (a minimum of one has a life-threatening injury), GTA 08-01-004, a secure mode of communication (SINCGARS with secure fill loaded to operate in CT, FH), frequencies and call signs of candidate's unit and MEDEVAC unit, and the information required to complete GTA 08-01-004.

**STANDARDS:** Collect all applicable information and prioritize casualties. Transmit lines 1 through 5 of the MEDEVAC request within 25 seconds. Complete all performance measures within 5 minutes.

**PERFORMANCE STEPS:**

1. Collect all applicable information needed for the MEDEVAC request.
  - a. Obtain the grid coordinates for the pickup site.
  - b. Obtain radio frequency, call sign, and suffix.
  - c. Determine the number of patients and precedence.
  - d. Determine the type of special equipment required.
  - e. Determine the number and type (litter or ambulatory) of patients.
  - f. Determine the security of the pickup site.
  - g. Determine how the pickup site will be marked.
  - h. Determine patient nationality and status.
  - i. Obtain pickup site NBC contamination information normally obtained from the senior person or medic.

**NOTE:** Information for steps 1a, 1b, and 1i will be provided to the candidate during the OPORD or scenario brief. Information for steps 1c through 1h must be determined by the candidate during testing of the task.

2. Record the gathered MEDEVAC information using the authorized brevity codes (GTA 08-01-004).
  - a. Location of pickup site (line 1).
  - b. Radio frequency, call sign, and suffix (line 2).
  - c. Number of patients by precedence (line 3).
  - d. Special equipment required (line 4).
  - e. Number of patients by type (line 5).
  - f. Security of pickup site (line 6).
  - g. Method of marking pickup site (line 7).
  - h. Patient nationality and status (line 8).
  - i. NBC contamination (line 9).
3. Transmit the MEDEVAC request.
  - a. Contact the unit that controls the evacuation assets.
    - (1) Make proper contact with the intended receiver.
    - (2) Use effective call sign and frequency assignments from the SOI.
    - (3) Give the following in the clear "I HAVE A MEDEVAC REQUEST;" wait 1 to 3 seconds for response. If no response, repeat the statement.
  - b. Transmit the MEDEVAC information in the proper sequence.

**NOTES:**

1. Line numbers 1 through 5 must always be transmitted during the initial contact with the evacuation unit. Lines 6 through 9 may be transmitted while the aircraft or vehicle is en route.
  - a. Follow the procedure provided in the explanation column of the MEDEVAC request format to transmit other required information.
  - b. Pronounce letters and numbers IAW appropriate radio telephone procedure.
2. The 25 second transmit time starts when the candidate says "LINE 1" and ends with the proword "OVER."
3. The proword "BREAK" must be given between each patient category in line 3 and between each patient type in line 5.
4. The 5-minute time limit ends when the candidate completes line 9 with the proword "OVER."

**PERFORMANCE MEASURES:**

	<b>GO</b>	<b>NO GO</b>
1. Collected all applicable information needed for the MEDEVAC request line items one through nine.	_____	_____
2. Recorded the information using the authorized brevity codes.	_____	_____
3. Transmitted lines 1 through 5 within 25 seconds using proper procedures/prowords.	_____	_____
4. Transmitted lines 6 through 9 using proper procedures/prowords.	_____	_____
5. Correctly performed all performance steps for each performance measure within 5 minutes.	_____	_____

**REFERENCES:**

**Required**

**Related**

FM 8-10-6

STP 21-24-SMCT, Task No. 081-831-0101

---

Figure 3-7. Prepare and Transmit a MEDEVAC Request (Using Secure Mode Radio).

---

## SUBMIT NBC 1 REPORT

**CONDITIONS:** An NBC attack has just occurred in your area. You have a watch, map, compass, protractor, pencil or pen, paper, and the NBC report format guide (GTA 03-06-08).

**STANDARDS:** Submit Spot Report to give attack notification. Submit NBC 1 Report using the correct format and content within 10 minutes.

### PERFORMANCE STEPS:

1. After protecting yourself from an NBC attack, submit a Spot Report immediately using the S-A-L-U-T-E format.

**NOTE:** The purpose of the Spot Report is to give immediate notification of the NBC attack.

a. Identify enemy activity. Determine whether observed activity is friendly or enemy. If unable to make determination, report activity as unknown.

b. Record information in a Spot Report, using the S-A-L-U-T-E format.

(1) The Spot Report is a report containing information for which speed of transmission is essential. A spot report does not have a prescribed format, but use of the S-A-L-U-T-E format will ensure reporting of essential information.

(a) S - Size. Report the number of personnel, vehicles, aircraft, or size of an object.

(b) A - Activity. Report detailed account of actions, such as, direction of movement, troops digging in, artillery fire, type of attack, and NBC activity.

(c) L - Location. Report where you saw the activity. Include grid coordinates or reference from a known point including the distance and direction from the known point.

(d) U - Unit. Report the enemy's unit. If the unit is unknown, report any distinctive features, such as uniforms, patches or colored tabs, headgear, and vehicle identification markings.

(e) T - Time. Report the time the activity was observed, not the time you report it. Always report local or Zulu time.

(f) E - Equipment. Report all equipment associated with the activity, such as weapons, vehicles, tools. If unable to identify the equipment, provide as much detail as you can so that higher headquarters can make an identification.

(2) Remarks. Include any information not included in the S-A-L-U-T-E format.

c. Provide a written spot report to chain of command (evaluator for testing purposes).

2. Submit NBC 1 (Observer's) Report after you have gathered available data.

a. Fill out required information as outlined in GTA 03-06-008.

(1) Line B. Location of observer (use grid coordinates or place name).

(2) Line D. Date-time group of the attack (specify local or Zulu time).

(3) Line H. Type and height of burst (if nuclear) or type of agent and persistency (if chemical or biological).

(4) Either Line C (direction of attack in mils or degrees from the observer) or Line F (location of attack - grid coordinates or place name).

b. Select proper communication precedence.

(1) If this is the first attack of its type (first nuclear, first biological, or first chemical) use FLASH precedence. FLASH precedence is used to report first use of NBC weapons against U.S. troops.

**NOTE:** FLASH reports should not be delayed for lack of any of the information.

(2) Use IMMEDIATE precedence for all other attacks.

c. Submit NBC 1 Report to higher headquarters (evaluator for testing purposes).

**PERFORMANCE MEASURES:**

**GO**      **NO  
GO**

- |  |       |       |
|--|-------|-------|
| 1. Submitted a written Spot Report immediately for attack notification using the S-A-L-U-T-E format. | _____ | _____ |
| 2. Submitted NBC 1 Report.   | _____ | _____ |
| 3. Correctly performed all performance steps for each performance measure within 10 minutes.         | _____ | _____ |

**REFERENCES:**

**Required**

**Related**

FM 3-3

FM 3-3-1

FM 3-11.4

FM 21-75

STP 21-1-SMCT, Task No. 031-503-3005

STP 21-1-SMCT, Task No. 301-371-1000

---

Figure 3-8. Submit NBC 1 Report.

### 3-12. COMMON SKILLS TASKS.

a. Objective. To measure the candidate's ability to apply common soldier skills to protect himself or herself and the casualty in a battlefield scenario.

b. Requirements. The candidate is required to complete 12 tasks, as indicated in paragraph 3-12c, below, and pass 9. These tasks are tested in a simulated battlefield scenario with the required equipment IAW paragraphs 3-5 and 3-6.

(1) The host unit will provide the following supplies/materials to the candidate:

(a) One set of nerve agent autoinjector training aids prior to the start of the combat lane.

(b) One M295 individual equipment decontamination kit (IEDK) and material for camouflage during testing of the applicable tasks.

(c) One loaded magazine with seven blank rounds and one dummy round prior to the start of the "Correct Malfunction of an M4 Carbine or M16-Series Rifle" task.

(2) Candidates will have their unit issued NBC supplies (except M295 IEDK and nerve agent autoinjector training aids) prior to the start of the combat lanes that require them.

c. Tasks. The tasks listed in this paragraph are tested using reaction-style testing.

(1) All candidates will be tested on the following tasks:

(a) Protect yourself from chemical/biological contamination using your assigned protective mask (Figure 3-9).

(b) Decontaminate yourself using chemical decontaminating kits (Figure 3-10).

(c) Protect yourself from NBC injury/contamination with mission-oriented protective posture (MOPP) gear (Figure 3-11).

(d) Perform self-aid for mild nerve agent poisoning (Figure 3-12).

(e) Protect yourself from biological or chemical injury/contamination when removing MOPP gear (Figure 3-13).

(f) Store the M40-series protective mask with hood (Figure 3-14).

(g) Correct malfunction of an M4 carbine or M16-series rifle (Figure 3-15).

(h) Disassemble and assemble an M9 pistol and perform a function check (Figure 3-16).

(i) Camouflage yourself and your individual equipment (Figure 3-17).

(j) Move under direct fire (Figure 3-18).

- (2) Candidates issued an M16-series rifle will be tested on—
  - (a) Disassemble and assemble an M16-series rifle (Figure 3-19).
  - (b) Perform a function check on an M16-series rifle (Figure 3-20).

- (3) Candidates issued an M4 or M4A1 carbine will be tested on—
  - (a) Disassemble and assemble an M4 or M4A1 carbine (Figure 3-21).
  - (b) Perform a function check on an M4 or M4A1 carbine (Figure 3-22).

d. Equipment. Candidates will be tested on the same equipment with the exception of their assigned protective mask, MOPP gear, and weapon. When testing the tasks involving the protective mask, if at all possible, all candidates should be tested on the same type of mask.

e. Changes. Changes are NOT authorized without an exception to policy approval.

---

**PROTECT YOURSELF FROM CHEMICAL/BIOLOGICAL CONTAMINATION  
USING YOUR ASSIGNED PROTECTIVE MASK**

**CONDITIONS:** Given your assigned protective mask with hood and carrier.

**STANDARDS:** Don, clear, and check your mask within 9 seconds.

**PERFORMANCE STEPS:**

**NOTE:** You must complete steps 1 through 3 within 9 seconds.

1. Don the mask as quickly as possible.

- a. Stop breathing and close your eyes. (Time starts now.)
- b. Remove your helmet.

(1) If you have the M17-, M24-, M25-, M40-, M43-, or M45-series protective mask, put your helmet between your legs (above your knees) or hold your rifle between your legs and place your helmet on the muzzle. If you drop your helmet, continue to mask.

(2) If you have the M42-series protective mask, remove your helmet and place it in a convenient location. Avoid placing it on a contaminated surface if possible.

**WARNING:** DO NOT WEAR CONTACT LENSES WITH THE PROTECTIVE MASK. REMOVE CONTACT LENSES WHEN THE USE OF CHEMICAL AGENTS IS IMMINENT.

- c. Take off your glasses, if applicable.
- d. Open the mask carrier with one hand.
- e. Grasp the mask assembly with your other hand and remove it from the carrier.
- f. Put your chin in the chin pocket and press the facepiece snugly against your face.

**NOTE:** The temple and forehead straps have already been adjusted during fitting.

g. Grasp the tab and pull the head harness over your head. Ensure that your ears are between the temple straps and the cheek straps. Ensure that the head harness is pulled far enough over so that the forehead straps are tight.

h. Use one hand to tighten the cheek straps, one at a time, while holding the head pad centered on the back of your head with the other hand. Ensure that the straps lay flat against your head.

2. Clear the mask.

a. Seal the outlet valve by pushing in on the center of the outlet valve cover with one hand.

b. Blow out hard to ensure that any contaminated air is forced out around the edges of the facepiece.

3. Check the mask.

a. Cover the inlet port of the filter canister (M40- and M45-series) or the inlet port of the armor quick disconnect (M42-series) with the palm of your hand and breathe in.

b. Ensure that the facepiece collapses against your face and remains so while you hold your breath (indicates that the mask is airtight).

c. Remove any hair, clothing, or other matter between your face and the mask if the facepiece does not collapse to your face.

4. Complete steps 1 through 3 within 9 seconds.

5. Resume breathing.

6. Secure the mask hood.

**NOTE:** There are no time standards for donning the hood.

**CAUTION:** BE CAREFUL WHEN PULLING ON THE HOOD, BECAUSE IT COULD SNAG ON THE BUCKLES OF THE HEAD HARNESS AND TEAR.

- a. If you have the M17-, M25-, M42-, or M43-series protective mask, pull the hood over your head and zip the front closed to cover all bare skin.
- b. If you have the M24- or M45-series protective mask, pull the M7 hood over your helmet and head so that it covers your shoulders.
- c. If you have the M40-series protective mask, don the hood so that it lies smoothly on your head.
  - (1) For masks equipped with the regular hood—
    - (a) Grasp the back edge of the hood skirt.
    - (b) Pull the hood completely over your head so that it covers the back of your head, neck, and shoulders.
    - (c) Zip the front of the hood closed by pulling the zipper slider downward.
    - (d) Tighten the drawcord.
    - (e) Secure the underarm straps by fastening and adjusting them.
    - (f) Put on your helmet. If you have a combat vehicle crewman (CVC) helmet—
      - (i) Disconnect the boom microphone from the helmet.
      - (ii) Connect the mask microphone to the receptacle in the helmet.
      - (iii) Grasp the helmet next to the ear cups, with your hand spread as far as possible.
      - (iv) Place the helmet over your head, tilting the helmet forward slightly so that the first contact when putting it on is with the forehead surface of the mask.
      - (v) Rotate the helmet back and down over your head until it is seated in position.
  - (2) For masks equipped with the quick-doff hood—
    - (a) Place your hands inside the hood and expand the elastic gathering around the neck of the hood.
    - (b) Stretch and carefully pull the hood over your head so that the hood covers your head, neck, and shoulders.
    - (c) Fasten and adjust the underarm straps.
    - (d) Put on your helmet (see above for the CVC helmet).
- 7. Close the mask carrier and continue your mission.
- 8. Perform all steps in sequence without becoming a casualty.

**PERFORMANCE MEASURES:**

	<b>GO</b>	<b>NO GO</b>
1. Donned the mask as quickly as possible.	_____	_____
2. Cleared the mask.	_____	_____
3. Checked the mask.	_____	_____
4. Completed steps 1 through 3 within 9 seconds.	_____	_____
5. Secured the mask hood.	_____	_____
6. Closed the mask carrier.	_____	_____
7. Correctly performed all applicable performance steps for each performance measure in sequence.	_____	_____



**REFERENCES:**  
**Required**

**Related**

FM 3-3

FM 3-11.4

TM 3-4240-279-10

TM 3-4240-280-10

TM 3-4240-346-10

STP 21-1-SMCT, Task No. 031-503-1035

---

Figure 3-9. Protect Yourself From Chemical/Biological Contamination  
Using Your Assigned Protective Mask.

---

**DECONTAMINATE YOURSELF USING CHEMICAL DECONTAMINATING KITS**

**CONDITIONS:** You are in mask only, with remaining assigned MOPP gear available. You have a full canteen of water, M8 detector paper, and M291 skin decontaminating kit (SDK). Your skin and eyes are contaminated.

**STANDARDS:** Decontaminate all exposed skin and your eyes within 5 minutes.

**PERFORMANCE STEPS:**

1. Decontaminate your skin using the M291 SDK.
  - a. Remove one decontaminating packet from the M291 SDK.
  - b. Tear packet open at notch. Remove packet, fully unfold applicator pad, and slip fingers into handle.
  - c. Scrub skin starting with hands, including back of hand, palm, and fingers.
  - d. Hold breath, close eyes, and lift the hood and mask away from chin.
  - e. Continue to hold breath and scrub face.
  - f. Wipe inside of mask which touches the face, then drop packet to the ground.
  - g. Reseal, clear, and check mask.
  - h. Using a second packet, scrub neck and ears and wipe hands.
  - i. Drop the decontamination packet to the ground.

**CAUTION:** THE M291 SKIN DECONTAMINATING KIT IS FOR EXTERNAL USE ONLY. KEEP DECONTAMINATING POWDER OUT OF YOUR EYES, MOUTH, CUTS, AND WOUNDS. THE DECONTAMINATING POWDER MAY SLIGHTLY IRRITATE YOUR SKIN OR EYES. USE WATER TO WASH THE TOXIC AGENT OUT OF YOUR EYES, CUTS, OR WOUNDS. AFTER DECONTAMINATION WITH WATER, COVER ANY EXPOSED CUTS OR WOUNDS WITH APPROPRIATE FIRST AID WRAP OR BANDAGES BEFORE HANDLING THE DECONTAMINATING PACKAGE.

2. Remove chemical agent contamination from the eyes.
  - a. Remove canteen from load-bearing equipment and open canteen cap.
  - b. Check canteen mouth with M8 detector paper.
  - c. Hold breath.
  - d. Lift the mask and continue to hold breath.
  - e. Flush the eyes with water from the canteen, ensuring that the water does not flow from one eye to the other eye.
  - f. Reseal, clear, and check the mask.

**PERFORMANCE MEASURES:**

	<b>GO</b>	<b>NO GO</b>
1. Decontaminated skin using the M291 SDK.	_____	_____
2. Decontaminated eyes.	_____	_____
3. Correctly performed all performance steps for each performance measure within 5 minutes.	_____	_____

**REFERENCES:  
Required**

**Related**

FM 3-5

FM 3-11.4

TM 3-4230-229-10

TM 3-4230-235-10

STP 21-1-SMCT, Task No. 031-503-1013

---

Figure 3-10. Decontaminate Yourself Using Chemical Decontaminating Kits.

---

## PROTECT YOURSELF FROM NBC INJURY/CONTAMINATION WITH MOPP GEAR

**CONDITIONS:** You are in mask only with remaining assigned MOPP gear available.

**STANDARDS:** Perform all steps in sequence and achieve MOPP 4 within 8 minutes.

### PERFORMANCE STEPS:

1. Put on MOPP gear for MOPP 1.

a. Don the trousers.

(1) Put the overgarment trousers on over your normal duty uniform.

(2) Secure the trousers by snapping and zipping them and adjusting the waistband for a snug fit.

(3) Do not fasten the bottom of the trousers at this time.

b. Don the jacket.

(1) Put on the overgarment jacket.

(2) Zip it up.

(3) Fasten the snaps/Velcro®.

c. Secure the jacket to the trousers by snapping the three snaps across the back of the jacket to the trousers.

2. Put on additional MOPP gear (protective overboots) to reach MOPP 2. (There are three types of protective overboots described below; apply the appropriate type.)

a. Put the older model chemical protective overboots on over your leather combat boots, lacing them IAW the instructions provided in the package.

**NOTE:** The older model has a single eyelet at the rear.

(1) Don the cover on either foot by centering your foot on the sole.

(2) Smooth the excess material as flat as possible.

(3) Lace the overboots.

(a) Thread the lace through the front eyelet so that the ends are the same length.

(b) Tie a single hitch by passing one lace end through each eyelet from the inside to the outside, drawing each lace end tight.

(c) Pass both ends through the rear eyelet from the inside to the outside.

(d) Bring the ends back through the side eyelets.

(e) Tighten the lace by working the slack out of it between the side and back eyelets.

**NOTE:** The lace should hold the rear eyelet firmly against the boot.

(4) Tie the lace tightly across the instep with a single hitch.

(5) Wrap the excess lace around your leg, tying the ends with a reef or bowknot.

(Go to step 2d.)

b. Put the newer model chemical protective overboots on over your leather combat boots, lacing them IAW the instructions provided in the package.

**NOTE:** The newer model has two rear eyelets.

(1) Don the cover on either foot by centering your foot on the sole.

(2) Tuck the excess front material under the front of your foot.

(3) Lace the overboots.

(a) Thread the lace through the front eyelet so that both ends are the same length.

(b) Pass each lace end through a side eyelet from the inside to the outside.

(c) Draw the lace up tightly, fastening it with a single knot.

(d) Pass the ends through the rear eyelets from the inside to the outside.

(e) Pull the lace up firmly, positioning the fishtails neatly at the sides of your ankle.

(f) Tie the lace firmly with a single knot in front.

(4) Wrap the loose lace ends around your leg, tying them firmly in front with a bowknot and tucking in the loose ends. (Go to step 2d.)

**NOTE:** The newer model method is being taught at the U.S. Army Chemical School. Units that still have the older model should continue to use the older model donning instructions.

- c. Put the green vinyl overboots on over your leather combat boots, securing them by pulling the rubber bands around the metal buttons.
  - d. Blouse the overgarment trouser legs over the chemical protective overboots.
  - e. Secure the closures of the overgarment trouser legs (zip and secure Velcro<sup>®</sup> closures of the overgarment trouser legs and tie the drawstrings firmly).
3. Put on additional MOPP gear to reach MOPP 4.
- a. Secure the MOPP gear by zipping all zippers and closing all closures.
  - b. Put on the chemical protective gloves (rubber gloves and liners).
  - c. Pull the elastic cuffs of the overgarment jacket sleeves over the cuffs of the chemical protective gloves.

**PERFORMANCE MEASURES:**

	<b>GO</b>	<b>NO GO</b>
1. Put on MOPP gear for MOPP 1.	_____	_____
2. Put on additional MOPP gear to reach MOPP 2.	_____	_____
3. Put on additional MOPP gear to reach MOPP 4.	_____	_____
4. Correctly performed all applicable performance steps for each performance measure within 8 minutes.	_____	_____

**REFERENCES:**

**Required**

**Related**

- FM 3-11.4
- TM 3-4240-279-10
- TM 3-4240-280-10
- TM 3-4240-300-10-2
- STP 21-1-SMCT, Task No. 031-503-1015

---

Figure 3-11. Protect Yourself From NBC Injury/Contamination With MOPP Gear.

---

## PERFORM SELF-AID FOR MILD NERVE AGENT POISONING

**CONDITIONS:** You are wearing your protective mask and MOPP gear (or remaining MOPP gear is available) and are experiencing mild signs and symptoms of nerve agent poisoning. One set of MARK I nerve agent antidote autoinjectors or one Antidote Treatment, Nerve Agent, Autoinjectors (ATNAA) is available.

**STANDARDS:** Correctly identify six of eight signs and symptoms of mild nerve agent poisoning, administer the antidote to self in the proper sequence, and secure the autoinjector within 5 minutes.

### PERFORMANCE STEPS:

**NOTES:** 1. The ATNAA system is a nerve agent antidote device that will be used by the Armed Forces. A single ATNAA delivers both the atropine and pralidoxime chloride (2 PAM Cl). The ATNAA will replace the MARK I when supplies are exhausted.

2. Nerve agent antidote training aids will be used to train and evaluate this task. Actual autoinjectors will not be used.

1. Identify mild signs and symptoms of nerve agent poisoning by stating six of the eight to the evaluator.

- a. Unexplained runny nose.
- b. Unexplained sudden headache.
- c. Excessive flow of saliva (drooling).
- d. Tightness of the chest causing breathing difficulties.
- e. Difficulty seeing (blurred vision).
- f. Muscular twitching around area of exposed or contaminated skin.
- g. Stomach cramps.
- h. Nausea.

2. Administer either the MARK I or ATNAA to self (self-aid).

a. MARK I.

(1) Prepare to administer one atropine injection.

(a) Remove one set of MARK I from your protective mask carrier, from the pocket of the MOPP suit, or from another location as specified by your unit standing operating procedure (SOP).

(b) With your nondominant hand, hold the set of injectors by the plastic clip with the big injector on top.

(c) With your dominant hand, check the injection site in order to avoid buttons and objects in pockets where injecting. For injections into the thigh, grasp the trouser cargo pocket and pull forward, clearing possible obstructions from the site.

(d) Grasp the small injector without covering or holding the needle (green) end and pull it out of the clip with a smooth motion.

(e) Form a fist around the autoinjector with the needle end (green) extending beyond the little finger end of the fist. Be careful not to inject yourself in the hand.

**NOTE:** If the injection is accidentally given in the hand, another small injector must be obtained and the injection given in the proper site.

(f) Place the needle end of the injector against the outer thigh muscle. For injections into the thigh, grasp the trouser cargo pocket and pull forward, clearing possible obstructions from the site.

**NOTES:** 1. The injection may be given in any part of the lateral thigh muscle from about a hand's width above the knee to a hand's width below the hip joint. 2. Very thin soldiers should give the injection in the upper, outer part of the buttocks.

**WARNING:** WHEN INJECTING ANTIDOTE IN THE BUTTOCKS, BE VERY CAREFUL TO INJECT ONLY INTO THE UPPER, OUTER QUARTER OF THE BUTTOCKS TO AVOID HITTING THE MAJOR NERVE THAT CROSSES THE BUTTOCKS. HITTING THE NERVE MAY CAUSE PARALYSIS.

(2) Administer the atropine injection.

(a) Push the injector into the muscle with firm, even pressure until it functions.

**NOTE:** A jabbing motion is not necessary to trigger the activating mechanism.

(b) Hold the injector firmly in place for at least 10 seconds.

(c) Remove the injector from your muscle and carefully place this used injector between two fingers of the hand holding the plastic clip.

(3) Prepare to administer one 2 PAM CI injection.

(a) Pull the large injector out of the clip and form a fist around the autoinjector with the needle end extending beyond the little finger.

(b) Place the needle (black) end of the injector against the injection site.

(4) Administer the 2 PAM CI injection.

(a) Push the injector into the muscle with firm, even pressure until it functions.

(b) Hold the injector firmly in place for at least 10 seconds.

(5) Drop the plastic clip without dropping the used injectors.

(6) Go to step 3, "Secure the used injectors."

b. ATNAA.

(1) Prepare to administer one ATNAA.

(a) Remove one ATNAA from your protective mask carrier, from the pocket of the MOPP suit, or from another location as specified by your unit SOP.

(b) Remove the autoinjector from the pouch.

(c) With your dominant hand, hold the ATNAA in your closed fist with the green needle end extending beyond the little finger in front of you at eye level.

(d) With your nondominant hand, grasp the safety (gray) cap with the thumb and first two fingers.

**CAUTION:** DO NOT COVER OR HOLD THE NEEDLE END WITH YOUR HAND, THUMB, OR FINGERS. YOU MAY ACCIDENTALLY INJECT YOURSELF.

(e) Pull the safety cap off the bottom of the injector with a smooth motion and drop it to the ground.

(f) With the nondominant hand, check the injection site in order to avoid buttons and objects in pockets where injecting. For injections into the thigh, grasp the trouser cargo pocket and pull forward, clearing possible obstructions from the site.

(g) Hold the ATNAA in your closed fist with the green needle end pointing out by your little finger.

(h) Place the needle end of the injector against the outer thigh muscle.

**NOTES:** 1. The injection may be given in any part of the lateral thigh muscle from about a hand's width above the knee to a hand's width below the hip joint. 2. Very thin soldiers should give the injection in the upper, outer part of the buttocks.

**WARNING:** WHEN INJECTING ANTIDOTE IN THE BUTTOCKS, BE VERY CAREFUL TO INJECT ONLY INTO THE UPPER, OUTER QUARTER OF THE BUTTOCKS TO AVOID HITTING THE MAJOR NERVE THAT CROSSES THE BUTTOCKS. HITTING THE NERVE MAY CAUSE PARALYSIS.

(2) Administer the injection.

(a) Push the injector into the muscle with firm, even pressure until it functions.

**NOTE:** A jabbing motion is not necessary to trigger the activating mechanism.

(b) Hold the injector firmly in place for at least 10 seconds.

(c) Remove the injector from your muscle.

3. Secure the used injectors. (The candidate will state steps 3a and 3b to the evaluator. The steps will not be performed.)
  - a. Use a hard surface to bend each needle to form a hook without tearing protective gloves or clothing.
  - b. Push the needle of each used injector (one at a time) through one of the pocket flaps of the protective overgarment.

**WARNING:** IF, WITHIN 5 TO 10 MINUTES AFTER ADMINISTERING THE FIRST SET OF INJECTIONS, YOUR HEART BEGINS BEATING RAPIDLY AND YOUR MOUTH BECOMES VERY DRY, DO NOT ADMINISTER ANOTHER SET OF INJECTIONS.

**NOTE:** After you have given yourself the first set of MARK I injections or one ATNAA, you most likely will not need additional antidote if you are ambulatory and know who and where you are. If needed, only a buddy, a combat lifesaver, or medical personnel will give additional injections.

**PERFORMANCE MEASURES:**

	<b>GO</b>	<b>NO GO</b>
1. Identified six of the eight signs of mild nerve agent poisoning.	_____	_____
2. Administered the nerve agent antidote to self.	_____	_____
3. Stated how to secure the used injectors.	_____	_____
4. Correctly performed all performance steps for each performance measure in sequence within 5 minutes.	_____	_____

**REFERENCES:**

**Required**

**Related**

DVC 08-36

DVC 08-37

FM 4-25.11

FM 8-285

STP 21-1-SMCT, Task No. 081-831-1044

---

Figure 3-12. Perform Self-Aid For Mild Nerve Agent Poisoning.



---

**PROTECT YOURSELF FROM BIOLOGICAL OR CHEMICAL INJURY/  
CONTAMINATION WHEN REMOVING MOPP GEAR**

**CONDITIONS:** You are in MOPP 4 with individual gear. Your MOPP gear is contaminated. Your Buddy is in MOPP 4 and is available for MOPP gear removal. You have your M291 SDK and your Buddy has M295 IEDK.

**STANDARDS:** Decontaminate your individual gear and equipment without spreading the contamination and place it on an uncontaminated surface. Remove your Buddy's overgarments, overboots, and gloves. Complete all steps without spreading the contamination within 20 minutes.

**PERFORMANCE STEPS:**

1. Decontaminate your individual gear without assistance.

**NOTE:** If at any time during the technique you suspect you have spread contamination onto your skin or undergarments, decontaminate immediately with the personal decontaminating kit. Then proceed with the MOPP gear removal.

a. Cover your gear (weapon, LCE, helmet, mask carrier, and rucksack) with your Buddy's M295 IEDK.

**NOTE:** Weapon will be cleared and placed on safe prior to decontamination.

**CAUTION:** Keep decontaminating powder out of eyes, lips, cuts, and wounds. Cover exposed cuts or wounds with appropriate first aid wrap or bandage prior to handling the packets.

b. Set your gear aside on an uncontaminated surface.

2. Decontaminate your Buddy's hood and mask.

a. Candidate—

(1) Loosens Buddy's drawcord (except quick-doff hood).

(2) Unattaches Buddy's underarm straps from under his or her arms and places straps over the shoulders.

(3) Reattaches Buddy's straps to the Velcro<sup>®</sup> and hook-and-pile patches on the bottom of his or her hood.

(4) Wipes Buddy's mask eye lens outserts first with M291 SDK.

(5) Wipes Buddy's entire mask from the top of the hood down with M291 SDK.

b. Candidate decontaminates his or her own gloves with the personal decontaminating kit after Buddy's mask is decontaminated.

3. Roll your Buddy's hood.

**NOTE:** For hoods with zippers, leave the zipper closed.

a. Candidate lifts Buddy's hood straight up off his or her shoulders by grasping the straps.

b. Candidate pulls Buddy's hood over his or her head until most of the back of his or her head is exposed, but the hood should not be completely over Buddy's face.

c. Candidate tells Buddy to place his or her hand over the voice transmitter, if necessary, to prevent the mask seal from being broken.

d. Candidate rolls Buddy's hood tightly, starting at the chin and working around the mask without pulling it completely off the back of his or her head.

4. Remove your Buddy's jacket.

a. Candidate—

(1) Unties Buddy's cord.

(2) Unfastens Buddy's snaps/Velcro<sup>®</sup> on the front of his or her jacket.

(3) Unzips Buddy's jacket.

(4) Unsnaps Buddy's snaps in the back of his or her jacket from his or her overgarment trousers.

- b. Candidate tells Buddy to make a fist.
- c. Candidate pulls Buddy's jacket off, turning the jacket inside out.
- d. Candidate places Buddy's jacket on the ground nearby with the black side up.

**NOTE:** Buddy will use the jacket later as an uncontaminated surface to stand on.

5. Remove your Buddy's trousers.
  - a. Candidate opens Buddy's trouser cuffs, waist snap, zipper and, if necessary, waist tabs.
  - b. Candidate grasps Buddy's trouser leg by the cuff.
  - c. Candidate tells Buddy to pull his or her legs from the trousers, one leg at a time.
6. Remove your Buddy's overboots.
  - a. Candidate tells Buddy to stand next to his or her jacket.
  - b. Candidate loosens Buddy's overboot strings.
  - c. Candidate pulls Buddy's overboots off, one at a time.
  - d. Candidate tells Buddy to step onto his or her jacket as his or her overboots are removed.
7. Remove your Buddy's rubber gloves. Candidate helps Buddy remove his or her rubber gloves and drops the gloves onto the contaminated ground so that the Buddy does not touch the outside of the rubber gloves with his or her bare hands.
8. Remove your Buddy's MOPP gear without further contaminating self or Buddy.

**PERFORMANCE MEASURES:**

	<b>GO</b>	<b>NO GO</b>
1. Decontaminated individual gear without assistance.	_____	_____
2. Decontaminated Buddy's hood and mask.	_____	_____
3. Rolled Buddy's hood.	_____	_____
4. Removed Buddy's jacket.	_____	_____
5. Removed Buddy's trousers.	_____	_____
6. Removed Buddy's overboots.	_____	_____
7. Removed Buddy's rubber gloves.	_____	_____
8. Removed Buddy's MOPP gear without further contaminating self or Buddy.	_____	_____
9. Correctly performed all performance steps for each performance measure within 20 minutes.	_____	_____

**REFERENCES:**

**Required**

**Related**

FM 3-5

STP 3-54B1-SM, Task No. 031-503-1023

---

Figure 3-13. Protect Yourself From Biological or Chemical Injury/  
Contamination When Removing MOPP Gear.

---

**STORE THE M40-SERIES PROTECTIVE MASK WITH HOOD**

**CONDITIONS:** Given the “ALL CLEAR” signal, remove your protective mask with hood and store it in its carrier.

**STANDARDS:** Remove protective mask and correctly store it inside its carrier within 1 minute.

**PERFORMANCE STEPS:**

1. Remove protective mask with hood after the "all clear" signal is given.
  - a. Remove helmet.
  - b. Unfasten the underarm straps.
  - c. Loosen the draw cord (except quick-doff hood).
  - d. Unzip the zipper on the hood (except quick-doff hood).
  - e. Remove the hood.
  - f. Loosen the cheek straps.
  - g. Remove the mask.
  - h. Replace helmet on head.
  - i. Remove any moisture that has accumulated on the hood and mask.
2. Store mask with hood.
  - a. Hold the front of the mask in a horizontal position.
  - b. Smooth the hood over the mask.
  - c. Pull the head harness over the front of the mask.
  - d. Fold the two edges of the hood over the outlet valve to create a “V” in the front of the hood.
  - e. Store the underarm straps and the cord in the “V.”
  - f. Fold the “V” upward to cover the eye lenses without letting the hood cover the chin opening.
  - g. Store the mask with hood inside the carrier with the eye lenses up and facing away from the body.
  - h. Close the carrier opening.

**PERFORMANCE MEASURES:**

	<b>GO</b>	<b>NO GO</b>
1. Removed protective mask with hood after the "all clear" signal was given.	_____	_____
2. Stored mask with hood.	_____	_____
3. Correctly performed all performance steps for each performance measure within 1 minute.	_____	_____

**REFERENCES:**

**Required**

**Related**

STP 21-1-SMCT, Task No. 031-503-1036

---

Figure 3-14. Store the M40-Series Protective Mask With Hood.

---

**CORRECT MALFUNCTION OF AN M4 CARBINE OR M16-SERIES RIFLE**

**CONDITIONS:** Given a magazine with seven blank rounds and one dummy round and your assigned M4 carbine or M16-series rifle.

**STANDARDS:** Eliminate the stoppage within 10 seconds when the rifle fails to fire.

**PERFORMANCE STEPS:**

1. React to a situation by returning fire and reducing stoppage by applying S-P-O-R-T-S.

**NOTE:** If your weapon malfunctions, remember S-P-O-R-T-S. This key word will help you remember these actions in sequence: Slap, Pull, Observe, Release, Tap, Shoot.

- a. Slap upward on the magazine to make sure it is properly seated.
  - b. Pull the charging handle all the way back.
  - c. Observe the ejection of the case or cartridge. Look into the chamber and check for obstructions.
  - d. Release the charging handle to feed a new round into the chamber. Do not ride the charging handle.
  - e. Tap the forward assist.
  - f. Shoot. If the rifle still does not fire, inspect it to determine the cause of the stoppage or malfunction and take appropriate remedial action.
2. Perform steps 1a through 1f in sequence.  
 3. Perform steps 1a through 1f in 10 seconds.

**PERFORMANCE MEASURES:**

	<b>GO</b>	<b>NO GO</b>
1. Returned fire and reduced stoppage by applying S-P-O-R-T-S.	_____	_____
a. Slapped upward on the magazine.		
b. Pulled the charging handle.		
c. Observed the ejection port.		
d. Released the charging handle.		
e. Tapped the forward assist.		
f. Shot the rifle.		
2. Performed steps 1a through 1f in sequence.	_____	_____
3. Performed steps 1a through 1f in 10 seconds.	_____	_____

**REFERENCES:**

**Required**

**Related**

FM 3-22.9  
 TM 9-1005-249-10  
 STP 7-11BC1-SM-TG, Task No. 071-311-2029

---

Figure 3-15. Correct Malfunction of an M4 Carbine or M16-Series Rifle.

**DISASSEMBLE AND ASSEMBLE AN M9 PISTOL AND  
PERFORM A FUNCTION CHECK**

**CONDITIONS:** Given an M9 pistol and a magazine.

**STANDARDS:** Clear, disassemble, and assemble an M9 pistol and perform a function check within 3 minutes.

**PERFORMANCE STEPS:**

1. Clear the pistol.

**NOTE:** The lever will initially be set in the "FIRE" position and an empty magazine will be in the pistol.

- a. Place the safety lever in the "SAFE" position.
  - b. Hold the pistol in the raised pistol position.
  - c. Depress the magazine release button; remove the magazine from the pistol.
  - d. Pull the slide to the rear.
  - e. Push the slide stop up, locking the slide to the rear.
  - f. Look into the chamber to ensure that it is empty.
2. Disassemble the pistol.
- a. Depress the slide stop and let the slide go forward.
  - b. With your right hand, hold the pistol with the muzzle slightly raised.
  - c. With your forefinger, press the disassembly lever button (Figure 3-16a).

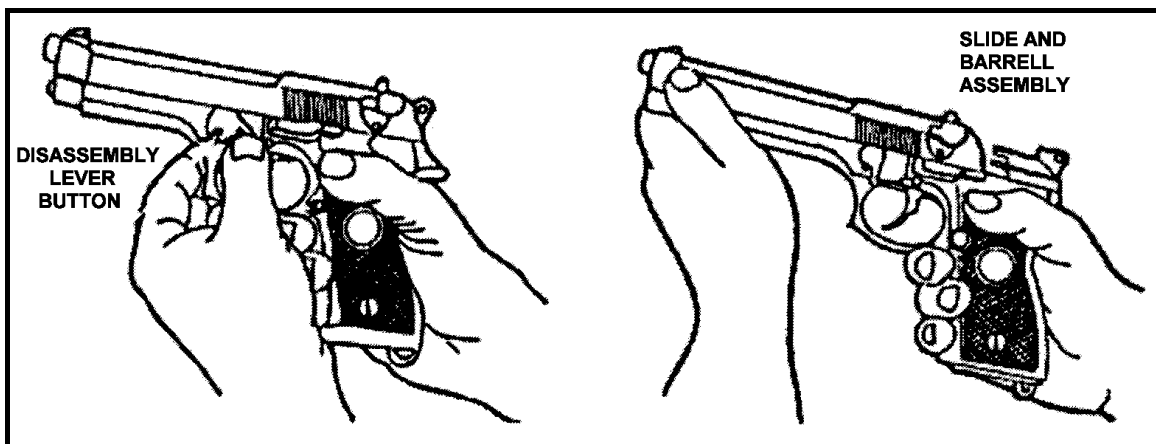

Figure 3-16a. Disassembly Lever Button.

- d. Rotate the disassembly lever downward until it stops.
- e. Pull the slide and barrel assembly forward (Figure 3-16a) and remove it from the receiver.
- f. Slightly compress the recoil spring and spring guide. At the same time, lift them up and remove them, allowing the recoil spring to stretch slowly (Figure 3-16b).

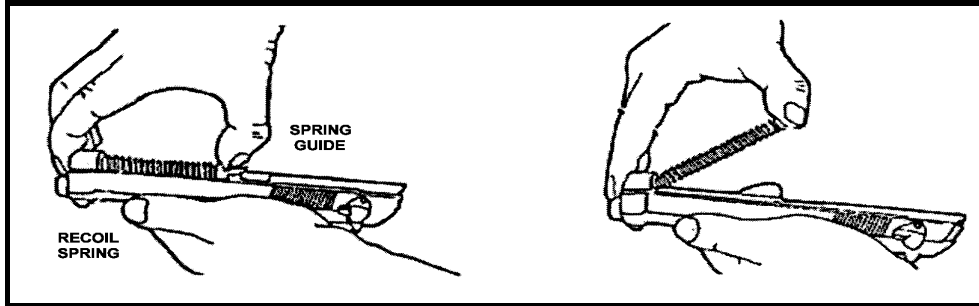

Figure 3-16b. Removing the Recoil Spring and Spring Guide.

- g. Separate the recoil spring from the spring guide.
- h. Push in on the locking block plunger while pushing the barrel forward slightly. Lift and remove the locking block and barrel assembly from the slide (Figure 3-16c).

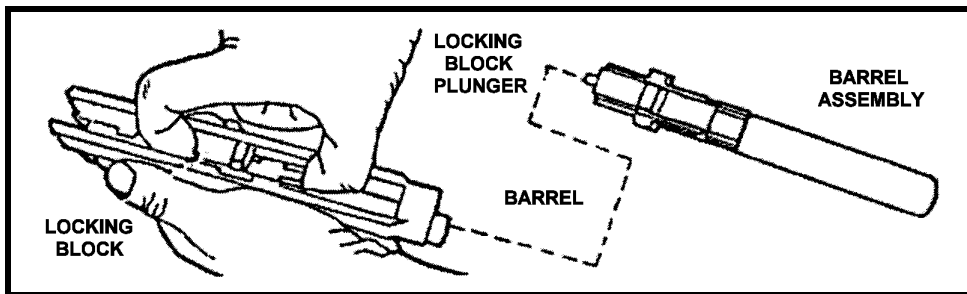

Figure 3-16c. Removing the Locking Block and Barrel Assembly.

- 3. Assemble the pistol (Figure 3-16d).

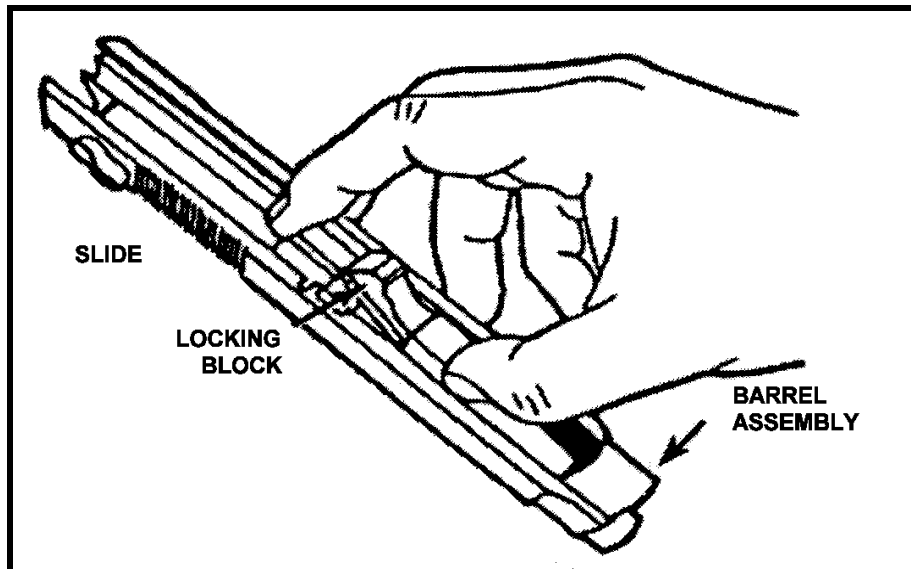

Figure 3-16d. Inserting the Barrel Assembly.

- a. Grasp the slide with the bottom facing up.
- b. With the other hand, grasp the barrel assembly with the locking block facing up.

- c. Insert the muzzle into the forward end of the slide. At the same time, lower the rear of the barrel assembly by moving the barrel slightly downward with light thumb pressure. The barrel will fall into place.
- d. Insert the recoil spring guide into the recoil spring (Figure 3-16e).



Figure 3-16e. Recoil Spring and Spring Guide.

- e. Insert the end of the recoil spring and the recoil spring guide into the recoil spring housing. At the same time, compress the recoil spring and lower the spring guide until it is fully seated on the locking block cutaway (Figure 3-16f).

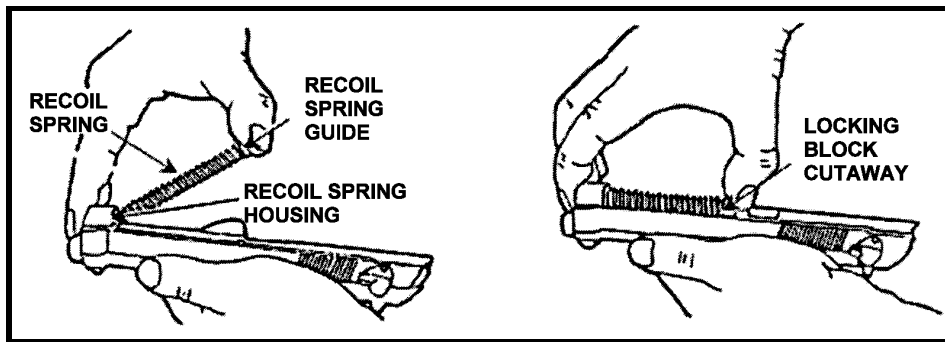

Figure 3-16f. Inserting the Recoil Spring and Guide.

**CAUTION:** BE SURE THAT THE HAMMER IS UNCOCKED AND FIRING PIN BLOCK LEVER IS IN THE DOWN POSITION. IF THE HAMMER IS COCKED, CAREFULLY AND MANUALLY LOWER THE HAMMER. DO NOT PULL THE TRIGGER WHILE PLACING THE SLIDE ONTO THE RECEIVER.

- f. Push the firing pin block lever down. Grasp the slide and barrel assembly, with the sights up and align the slide on the receiver assembly guide rails (Figure 3-16g).

- g. Push until the rear of the slide is a short distance beyond the rear of the receiver assembly and hold. At the same time, rotate the disassembly latch lever upward. A click indicates a positive lock.

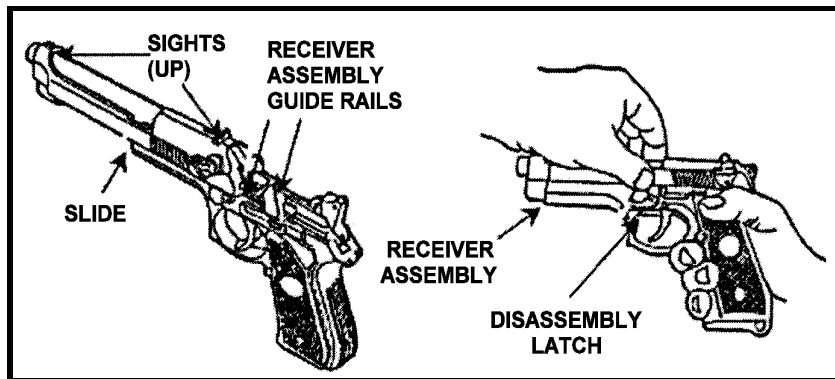

Figure 3-16g. Final Assembly.

4. Perform a function check.
  - a. Depress the slide stop. Insert an empty magazine into the pistol and ensure that the magazine catch locks the magazine in place.
  - b. Retract the slide and release it. The magazine follower should push up on the slide stop, locking the slide to the rear.
  - c. Depress the magazine release button allowing the magazine to fall free.
  - d. Ensure that the decocking/safety lever is in the safe (down) position. Depress the slide stop allowing the slide to return fully forward. At the same time, the hammer should fall to the full forward position.
  - e. Pull and release trigger. Firing pin block should move up and down.
  - f. Place decocking/safety lever in fire (up) position.
  - g. Pull trigger to check double action. Hammer should cock and fall.
  - h. Pull trigger again and hold to rear. Manually retract and release slide while holding trigger to the rear. Release trigger, click should be heard, hammer should not fall.
  - i. Pull trigger to check single action. Hammer should fall.

<b>PERFORMANCE MEASURES:</b>	<b>GO</b>	<b>NO GO</b>
1. Cleared the pistol.	_____	_____
2. Disassembled the pistol.	_____	_____
3. Assembled the pistol.	_____	_____
4. Performed a function check.	_____	_____
5. Correctly performed all performance steps for each performance measure within 3 minutes.	_____	_____

**REFERENCES:**

**Required**

**Related**

TM 9-1005-317-10

STP 21-1-SMCT, Task No. 071-004-0001

---

Figure 3-16. Disassemble and Assemble an M9 Pistol and Perform a Function Check.



---

**CAMOUFLAGE YOURSELF AND YOUR INDIVIDUAL EQUIPMENT**

**CONDITIONS:** Given your paint stick and pieces of burlap or similar material.

**STANDARDS:** Camouflage your exposed skin and change the outline and pattern of your clothing, equipment, and weapon within 15 minutes to prevent detection.

**PERFORMANCE STEPS:**

1. Cover or remove the following items eliminating light reflection:
  - a. Mirrors.
  - b. Civilian and aviation eye glasses.
  - c. Watch crystals.
  - d. Plastic map cases.
  - e. Starched uniforms.
  - f. Dust goggles worn on top of helmets.
  - g. Cigarettes and pipes.
  - h. Red-filtered flashlights.
  - i. Snap buttons with exposed brass on prescribed equipment.

2. Camouflage your skin.

**NOTE:** Exposed skin reflects light.

- a. Cover your skin oils, even if you have very dark skin, using paint sticks.

**NOTES:** 1. Paint sticks cover these oils and provide blending with the background.

2. Do not use oils or insect repellent to soften paint sticks. This defeats the purpose of paint sticks by making the skin shiny.

- b. Use the following when applying paint on the face:

(1) Paint high, shiny areas (forehead, cheekbones, nose, ears, chin) with a dark color.

(2) Paint low, shadow areas with a light color.

- c. Paint exposed skin on the back of the neck and hands with an irregular pattern.

3. Camouflage your BDU and helmet.

- a. Roll your sleeves down and button all buttons.
- b. Attach leaves, grass, small branches, or pieces of burlap to your uniform and helmet.

**NOTES:** 1. These items will distort shapes and blend colors with the natural background. 2. The BDU provides visual and near-infrared camouflage. (Do not use starched BDUs since starch counters the infrared properties of the dyes.)

4. Camouflage your personal equipment.

- a. Cover or remove shiny items (rings, watches, necklaces).
- b. Secure items that rattle or make noise when moved or worn.

5. Camouflage your prescribed equipment (LCE with accessories, weapon, and rucksack).

6. Ensure that camouflage does not reduce the function of the prescribed equipment.

**PERFORMANCE MEASURES:**

	<b>GO</b>	<b>NO GO</b>
1. Covered or removed any light-reflecting items.	_____	_____
2. Camouflaged exposed skin.	_____	_____
3. Camouflaged uniform and helmet.	_____	_____
4. Camouflaged personal equipment.	_____	_____
5. Camouflaged prescribed equipment.	_____	_____

**PERFORMANCE MEASURES:**

**GO**    **NO  
GO**

- |  |       |       |
|--|-------|-------|
| 6. Camouflage did not reduce the function of the prescribed equipment.                       | _____ | _____ |
| 7. Correctly performed all performance steps for each performance measure within 15 minutes. | _____ | _____ |

**REFERENCES:**

**Required**

**Related**

STP 21-1-SMCT, Task No. 052-191-1361

---

Figure 3-17. Camouflage Yourself and Your Individual Equipment.

---

## MOVE UNDER DIRECT FIRE

**CONDITIONS:** Given a tactical situation where you are coming under direct fire from across varied terrain and are armed with an M16-series rifle or M4-series carbine with a full magazine of blank rounds.

**STANDARDS:** Move under direct fire using the correct individual tactical fire and movement techniques that are dictated by terrain features.

### PERFORMANCE STEPS:

**NOTES:** 1. Each individual movement technique may be tested on one portion of a lane, throughout the lane, or other combat lanes dictated by terrain features and lane flow of tested tasks. 2. Each movement technique will be tested only one time. 3. The actual distance for each movement technique will be determined by the test board chairperson.

1. Select an individual movement route.

a. Search the terrain to your front for—

(1) A gully, ravine, ditch, or wall at a slight angle to your direction of movement.

**NOTE:** These features provide cover and concealment when using the low or high crawl.

(2) Hedgerows or a line of thick vegetation.

**NOTE:** These features only provide concealment when using the low or high crawl.

(3) Large trees, rocks, stumps, fallen timber, rubble, vehicle hulks, folds or creases in the ground.

**NOTE:** These features provide cover and concealment for use as temporary positions. Use the rush if the area between them has no concealment.

(4) High grass or weeds.

**NOTE:** These features only provide partial concealment. You may use the rush since the use of the high or low crawl could reveal your location by the movement of vegetation.

b. Select your next position (and the route to it) as one that—

(1) Exposes you to the least enemy fire.

(2) Does not require you to cross in front of other members of your element, masking their fires.

2. Determine the correct individual movement technique.

a. Select the high crawl when—

(1) The route provides cover and concealment.

(2) Poor visibility reduces enemy observation.

(3) Speed is required, but the terrain and vegetation are suitable only for the low crawl.

b. Select the low crawl when—

(1) The route provides cover or concealment less than 1-foot high.

(2) Visibility provides the enemy good observation.

(3) Speed is not required.

c. Select the rush when—

(1) You must cross open areas.

(2) Time is critical.

3. Use the high crawl (Figure 3-18a). (The distance will not exceed 25 meters.)



Figure 3-18a. High Crawl.

- a. Keep your body off of the ground.
  - b. Rest your weight on your forearms and lower legs.
  - c. Cradle your weapon in your arms, keeping its muzzle off the ground.
  - d. Keep your knees well behind your buttocks so it stays low.
  - e. Move forward by alternately advancing your right elbow and left knee, and left elbow and right knee.
4. Use the low crawl (Figure 3-18b). (The distance will not exceed 20 meters.)

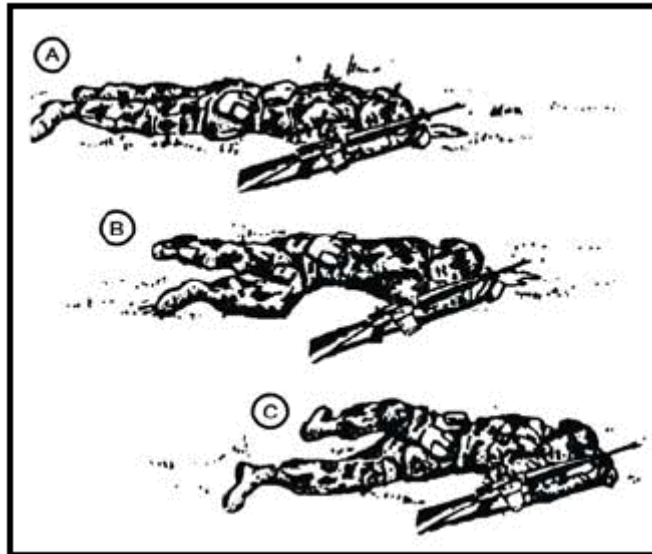

Figure 3-18b. Low Crawl.

- a. Keep your body as flat as possible to the ground.
- b. Hold your weapon by grasping the sling at the upper sling swivel, letting the handguard rest on your forearm and the butt of the weapon drag on the ground, thus keeping the muzzle off the ground.
- c. Move forward by—
  - (1) Pushing both arms forward while pulling your right leg forward.
  - (2) Pulling with both arms while pushing with your right leg.
  - (3) Continuing this push-pull movement until you reach your next position, changing your pushing leg frequently to avoid fatigue.

5. Use the rush to move from one covered position to another when enemy fire allows brief exposure (Figure 3-18c). (The distance will not exceed 50 meters.)
  - a. Move from your firing position by rolling or crawling.
  - b. Start from the prone position.
  - c. Select your next position by slowly raising your head.
  - d. Lower your head while drawing your arms into your body, keeping your elbows down and pulling your right leg forward.
  - e. Raise your body in one movement by straightening your arms.
  - f. Spring to your feet, stepping off with either foot.
  - g. Run to the next position—
    - (1) Keeping the distance short to avoid accurate enemy fire.
    - (2) Trying not to stay up any longer than 3 to 5 seconds so that the enemy does not have time to track you with automatic fire.
  - h. Plant both feet just before hitting the ground.
  - i. Fall forward by:
    - (1) Sliding your right hand down to the heel of the butt of your weapon.
    - (2) Breaking your fall with the butt of your weapon.
  - j. Assume a firing position.
    - (1) Roll on your side.
    - (2) Place the butt of your weapon in the hollow of your shoulder.
    - (3) Roll or crawl to a covered or concealed firing position.

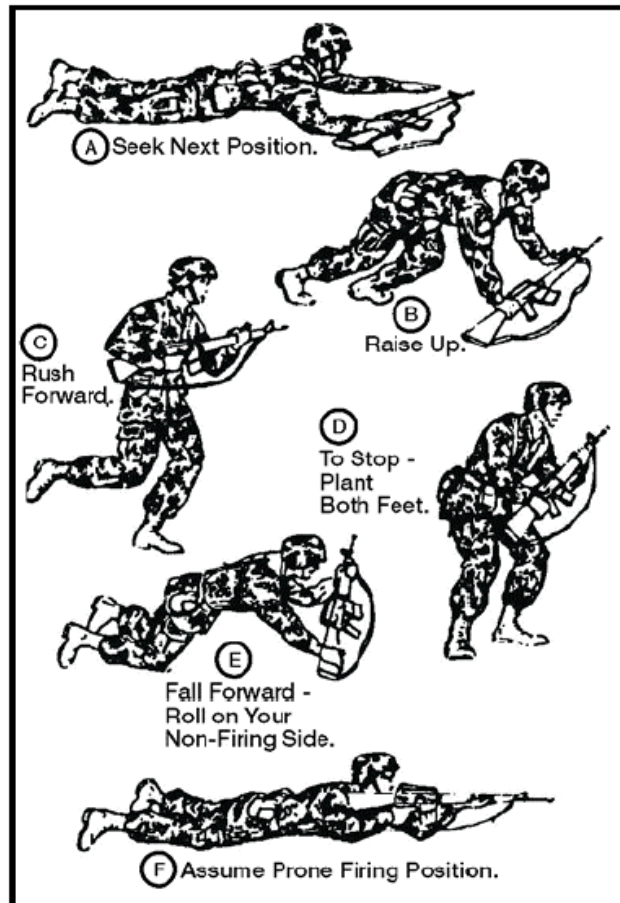

Figure 3-18c. Rush.

**PERFORMANCE MEASURES:**

**GO**    **NO  
GO**

- |  |       |       |
|--|-------|-------|
| 1. Selected an individual movement route that provided cover or concealment. | _____ | _____ |
| 2. Determined the correct individual movement technique.                     | _____ | _____ |
| 3. Used the high crawl.  | _____ | _____ |
| 4. Used the low crawl.   | _____ | _____ |
| 5. Used the rush to move from one covered position to another.               | _____ | _____ |
| 6. Correctly performed all performance steps for each performance measure.   | _____ | _____ |

**REFERENCES:**  
**Required**

**Related**  
FM 21-75  
STP 21-1-SMCT, Task No. 071-326-0502

---

Figure 3-18. Move Under Direct Fire.

---

**DISASSEMBLE AND ASSEMBLE AN M16-SERIES RIFLE**

**CONDITIONS:** Given your assigned M16-series rifle and a magazine.

**STANDARDS:** Clear, disassemble, and assemble an M16-series rifle so that it functions correctly within 4 minutes.

**PERFORMANCE STEPS:**

1. Clear the rifle.

**NOTE:** The magazine will initially be in the rifle.

- a. Turn the selector to "SAFE" (if applicable).
  - b. Remove the magazine.
  - c. Verify the rifle is clear.
2. Disassemble the rifle into 13 parts.
- a. Remove the sling.
  - b. Push both takedown pins as far as they will go and separate the upper receiver from the lower receiver.
  - c. Pull back the charging handle.
  - d. Remove the bolt carrier.
  - e. Remove the charging handle.
  - f. Remove the firing pin retaining pin.
  - g. Put the bolt assembly in the locked position by pushing in the bolt.
  - h. Remove the firing pin by allowing it to drop out of the rear of the bolt carrier into your hand.
  - i. Remove the bolt cam pin by turning it one-quarter turn and lifting it out.
  - j. Pull the bolt assembly from the carrier.
  - k. Remove the extractor pin by pushing it out with the firing pin (use care not to damage the firing pin).
  - l. Lift out the extractor and spring, taking care so that the spring does not separate from the extractor.
  - m. Release the buffer by pressing the buffer and depressing the retainer.
  - n. Remove the buffer and action spring separating the buffer from the spring.
  - o. Do not disassemble the rifle further.

**NOTE:** There is no required sequence for disassembly.

3. Assemble the rifle.

- a. Insert the spring and buffer.
- b. Insert the extractor and spring.
- c. Push the extractor pin in.
- d. Slide the bolt into the carrier until the bolt cam pinhole in both the bolt carrier and the bolt are aligned.
- e. Place the bolt cam pin by putting it in the bolt carrier and turning it one-quarter turn.
- f. Drop in the firing pin to seat it.
- g. Put the firing pin retaining pin in the bolt carrier to seat it.
- h. Pull the bolt back.
- i. Place the charging handle by engaging it, then pushing the charging handle part of the way in.
- j. Slide the bolt carrier into the upper receiver.
- k. Push the charging handle and bolt carrier together in the upper receiver.
- l. Join the upper and lower receiver.
- m. Engage the receiver pivot pin.

**CAUTION:** THE SELECTOR LEVER MUST BE ON "SAFE" BEFORE CLOSING THE UPPER RECEIVER.

- n. Close the upper and lower receiver groups, seating the takedown pin and ensuring the selector switch is on "SAFE."
- o. Replace the sling.
- p. Insert the magazine.

**NOTE:** There is no required sequence for assembly.

**PERFORMANCE MEASURES:**

	<b>GO</b>	<b>NO GO</b>
1. Cleared the rifle.	_____	_____
2. Disassembled the rifle into 13 parts.	_____	_____
3. Assembled the rifle.	_____	_____
4. Correctly performed all performance steps for each performance measure within 4 minutes.	_____	_____

**REFERENCES:**

**Required**

**Related**

FM 3-22.9

TM 9-1005-249-10

STP 21-1-SMCT, Task No. 071-311-2025

GTA 21-1-3

---

Figure 3-19. Disassemble and Assemble an M16-Series Rifle.



**PERFORM A FUNCTION CHECK ON AN M16-SERIES RIFLE**

**CONDITIONS:** Given your assigned M16-series rifle.

**STANDARDS:** Perform a function check within 1 minute; ensure that the rifle operates properly with the selector switch in each position.

**PERFORMANCE STEPS:**

1. Check an M16A1, M16A2, or M16A4 with the selector lever in the "SAFE" position (Figure 3-20a).

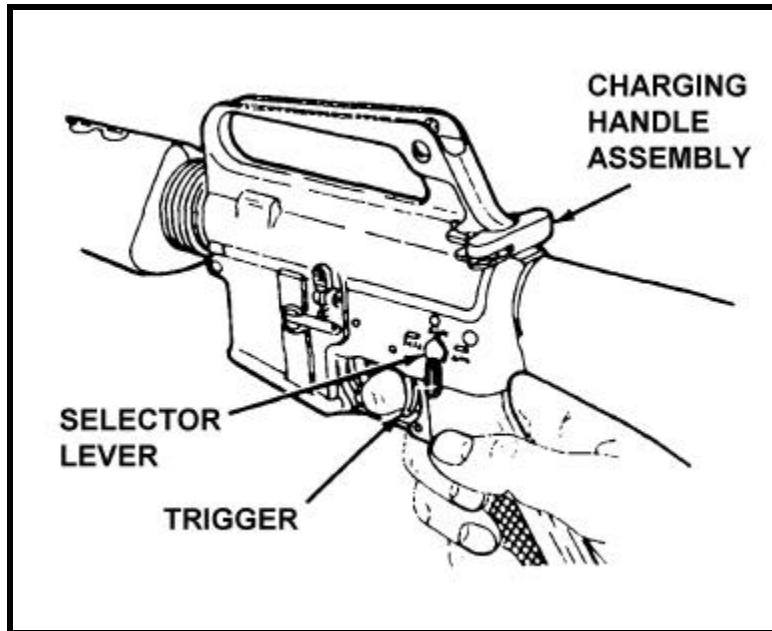

Figure 3-20a. M16 Rifle.

- a. Pull the charging handle to the rear and release it.
- b. Place the selector lever in the "SAFE" position.
- c. Pull the trigger (the hammer should not fall).
2. Check an M16A1, M16A2, or M16A4 with the selector lever in the "SEMI" position.
  - a. Place the selector lever in the "SEMI" position.
  - b. Pull the trigger, holding it to the rear (the hammer should fall).
  - c. Continue to hold the trigger to the rear while pulling the charging handle to the rear and releasing the charging handle.
  - d. Release the trigger with a slow, smooth motion until the trigger is fully forward (the hammer should not fall).
  - e. Pull the trigger (the hammer should fall).
3. Check an M16A1 with the selector lever in the "AUTO" position.
  - a. Place the selector lever in the "AUTO" position.
  - b. Pull the charging handle to the rear and release it.
  - c. Pull the trigger holding it to the rear (the hammer should fall).
  - d. Continue to hold the trigger to the rear while pulling the charging handle to the rear and releasing the charging handle.
  - e. Release the trigger.

- f. Pull the trigger (the hammer should not fall).
4. Check an M16A2 or M16A4 with the selector lever in the "BURST" position.
  - a. Place the selector lever in the "BURST" position.
  - b. Pull the charging handle to the rear and release it.
  - c. Pull the trigger, holding it to the rear (the hammer should fall).
  - d. Continue to hold the trigger to the rear while pulling the charging handle to the rear and releasing the charging handle.
  - e. Repeat step 4d two more times.
  - f. Release the trigger.
  - g. Pull the trigger (the hammer should fall).
5. Inform the evaluator of any malfunction of the rifle during the function check.

**PERFORMANCE MEASURES:**

	<b>GO</b>	<b>NO GO</b>
1. Checked an M16-series rifle with the selector lever in the "SAFE" position; verified the hammer did not fall.	_____	_____
2. Checked an M16-series rifle with the selector lever in the "SEMI" position; verified the hammer fell.	_____	_____
<b>NOTE:</b> <i>Performed either step 3 or 4, as appropriate.</i>		
3. Checked an M16A1 rifle with the selector lever in the "AUTO" position; verified the hammer did not fall.	_____	_____
4. Checked an M16A2 or M16A4 rifle with the selector lever in the "BURST" position; verified the hammer fell.	_____	_____
5. Informed the evaluator of any malfunction of the rifle during the function check.	_____	_____
6. Correctly performed all applicable performance steps for each performance measure within 1 minute.	_____	_____

**REFERENCES:**

**Required**

**Related**

TM 9-1005-249-10

STP 7-11BC1-SM-TG, Task No. 071-311-2026

---

Figure 3-20. Perform a Function Check on an M16-Series Rifle.

---

## DISASSEMBLE AND ASSEMBLE AN M4 OR M4A1 CARBINE

**CONDITIONS:** Given your assigned M4 or M4A1 carbine and a magazine.

**STANDARDS:** Clear, disassemble, and assemble the carbine so that it functions correctly within 4 minutes.

### PERFORMANCE STEPS:

1. Clear the carbine.

**NOTE:** The magazine will initially be in the carbine.

- a. Remove the magazine.
- b. Cock the carbine.
- c. Turn the selector to "SAFE" (if applicable).

**NOTE:** The selector cannot be turned to "SAFE" unless the carbine is cocked.

- d. Lock the bolt open.
  - (1) Pull the charging handle rearward.
  - (2) Press the bottom of the bolt catch.
  - (3) Allow the bolt to move forward until it engages the bolt catch.
  - (4) Return the charging handle to the forward position.
- e. Check the receiver and chamber to ensure that they do not contain ammunition.

2. Disassemble the carbine into 13 parts.

- a. Remove the sling.
- b. Push the takedown pin as far as it will go and pivot the upper receiver from the lower receiver.
- c. Push the receiver pivot pin.
- d. Separate the upper and lower receivers.
- e. Pull back the charging handle.
- f. Remove the bolt carrier and bolt.
- g. Remove the charging handle.
- h. Remove the firing pin retaining pin.
- i. Put the bolt assembly in the locked position by pushing in the bolt.
- j. Remove the firing pin by allowing it to drop out of the rear of the bolt carrier into your hand.
- k. Remove the bolt cam pin by turning it one-quarter turn and lifting it out.
- l. Pull the bolt assembly from the carrier.
- m. Remove the extractor pin by pushing it out with the firing pin (use care not to damage the firing pin).
- n. Lift out the extractor and spring, taking care that the spring does not separate from the extractor.
- o. Release the buffer by pressing the buffer and depressing the retainer.
- p. Remove the buffer and action spring separating the buffer from the spring.

**NOTE:** There is no required sequence for disassembly.

3. Assemble the carbine.

- a. Insert action spring and buffer.
- b. Insert extractor and spring.
- c. Push in extractor pin.
- d. Slide bolt into carrier.

**WARNING:** BE SURE THAT THE CAM PIN IS INSTALLED IN THE BOLT GROUP. IF IT IS NOT, THE CARBINE CAN STILL FIRE AND WILL EXPLODE.

- e. Replace bolt cam pin.
- f. Drop in and seat firing pin.

- g. Pull bolt back.
- h. Replace retaining pin.
- i. Engage, then push charging handle in part of the way.
- j. Slide in bolt carrier group.
- k. Push in charging handle and bolt carrier group together.
- l. Join upper and lower receivers.
- m. Engage receiver pivot pin.
- n. Close upper and lower receiver groups. Push in takedown pin.
- o. Replace the sling.
- p. Insert the magazine.

**NOTE:** There is no required sequence for assembly.

**PERFORMANCE MEASURES:**

	<b>GO</b>	<b>NO GO</b>
1. Cleared the carbine.	_____	_____
2. Disassembled the carbine into 13 parts.	_____	_____
3. Assembled the carbine.	_____	_____
4. Correctly performed all performance steps for each performance measure within 4 minutes.	_____	_____

**REFERENCES:**

**Required**

**Related**

TM 9-1005-319-10

STP 21-1-SMCT, Task No. 071-100-0004

---

Figure 3-21. Disassemble and Assemble an M4 or M4A1 Carbine.

---

**PERFORM A FUNCTION CHECK ON AN M4 OR M4A1 CARBINE**

**CONDITIONS:** Given your assigned M4 or M4A1 carbine.

**STANDARDS:** Perform a function check within 1 minute; ensure that the carbine operates properly with the selector switch in each position.

**PERFORMANCE STEPS:**

1. Check an M4 or M4A1 carbine with the selector lever in the "SAFE" position.
  - a. Pull the charging handle to the rear and release it.
  - b. Place the selector lever in the "SAFE" position.
  - c. Pull the trigger (the hammer should not fall).
2. Check an M4 or M4A1 carbine with the selector lever in the "SEMI" position.
  - a. Place the selector lever in the "SEMI" position.
  - b. Pull the trigger, holding it to the rear (the hammer should fall).
  - c. Continue to hold the trigger to the rear while pulling the charging handle to the rear and releasing the charging handle.
  - d. Release the trigger with a slow, smooth motion until the trigger is fully forward (the hammer should not fall).
  - e. Pull the trigger (the hammer should fall).
3. Check an M4A1 carbine with the selector lever in the "AUTO" position.
  - a. Place the selector lever in the "AUTO" position.
  - b. Pull the charging handle to the rear and release it.
  - c. Pull the trigger (the hammer should fall).
  - d. Hold the trigger to the rear and cock the weapon.
  - e. Fully release the trigger then pull it to the rear again; the hammer should not fall.
4. Check an M4 carbine with the selector lever in the "BURST" position.
  - a. Place the selector lever in the "BURST" position.
  - b. Pull the charging handle to the rear and release it.
  - c. Pull the trigger, holding it to the rear (the hammer should fall).
  - d. While holding the trigger to the rear, pull the charging handle to the rear and release the charging handle.
  - e. Repeat step 4d two more times.
  - f. Release the trigger.
  - g. Pull the trigger (the hammer should fall).
5. Inform the evaluator of any malfunction of the carbine during the function check.

**PERFORMANCE MEASURES:**

	<b>GO</b>	<b>NO GO</b>
1. Checked an M4 or M4A1 carbine with the selector lever in the "SAFE" position; verified the hammer did not fall.	_____	_____
2. Checked an M4 or M4A1 carbine with the selector lever in the "SEMI" position; verified the hammer fell.	_____	_____
<b>NOTE:</b> <i>Performed either step 3 or 4, as appropriate.</i>		
3. Checked an M4A1 carbine with the selector lever in the "AUTO" position; verified the hammer did not fall.	_____	_____
4. Checked an M4 carbine with the selector lever in the "BURST" position; verified the hammer fell.	_____	_____

**PERFORMANCE MEASURES:**

**GO**    **NO  
GO**

- |   |       |       |
|---|-------|-------|
| 5. Informed the evaluator of any malfunction of the carbine during the function check.                | _____ | _____ |
| 6. Correctly performed all applicable performance steps for each performance measure within 1 minute. | _____ | _____ |

**REFERENCES:**

**Required**

**Related**

TM 9-1005-319-10

STP 7-11BC1-SM-TG, Task No. 071-100-0005

---

Figure 3-22. Perform a Function Check on an M4 or M4A1 Carbine.

**3-13. EMERGENCY MEDICAL TREATMENT TASKS.**

a. Objective. To measure the candidate's ability to prioritize casualties and apply emergency medical treatment skills in a battlefield scenario.

b. Requirements. The candidate is required to complete the 10 tasks listed in paragraph 3-13c, below, within 1 hour, and pass 8 of the 10. The tasks are tested in a simulated battlefield scenario with the required equipment IAW paragraphs 3-5 and 3-6. The candidates' aid bags will contain the items on a packing list provided by the EFMB test board. The candidate is placed in a scenario with four simulated casualties. The casualties have a maximum of two injuries each and must receive proper triage and treatment within the 1-hour time limit. At the end of 1 hour, the tasks not completed will be scored a NO GO. This includes completing a Department of Defense (DD) Form 1380 (U.S. Field Medical Card) and performing a casualty assessment for each casualty.

c. Tasks. The following tasks are tested in a lane using reaction-style testing.

- (1) Triage casualties on a conventional battlefield (Figure 3-23).
- (2) Perform a casualty assessment (Figure 3-24).
- (3) Control bleeding (Figure 3-25).
- (4) Treat a casualty with an open chest wound (Figure 3-26).
- (5) Treat a casualty with an open abdominal wound (Figure 3-27).
- (6) Immobilize a suspected fracture of the arm (Figure 3-28).
- (7) Initiate treatment for hypovolemic shock (Figure 3-29).
- (8) Treat a casualty with an open head injury (Figure 3-30).
- (9) Initiate an intravenous (IV) infusion (Figure 3-31).
- (10) Initiate a U.S. Field Medical Card (Figure 3-32).

d. Equipment.

- (1) The host unit may not recycle used consumable medical supplies during testing.
- (2) The host unit will have hazardous waste disposable containers for each emergency medical treatment lane.
- (3) Candidates are required to pack their own aid bags prior to the start of the lane. Improper packing of the aid bags by the candidates is not grounds for rebuttal. The EFMB test board will provide the final packing list.
- (4) Table 3-3 contains a recommended packing list.

**Table 3-3. Aid bag packing list.**

<b>ITEM</b>	<b>QUANTITY</b>	<b>ITEM</b>	<b>QUANTITY</b>
Abdominal dressings	2 each	Gauze, 2- x 2-inch	2 each
Alcohol pads	5 each	Gloves	5 pair
Bandage scissors	1 each	IV fluids	2 each
Blanket, casualty	1 each	IV starter sets	2 each
Catheter, 16 gauge or larger	2 each	Splints	2 each
Cravats	20 each	Tape, 1-inch	1 roll
DD Form 1380	4 each	Pin light	1 each
First aid dressings	5 each	Tourniquet (IV)	1 each
Cervical Collar	1 each	Stethoscope	1 each
Sphygmomanometer	1 each		

- e. Changes. Changes are NOT authorized without an exception to policy approval.



---

## TRIAGE CASUALTIES ON A CONVENTIONAL BATTLEFIELD

**CONDITIONS:** Given four casualties with conventional injuries.

**STANDARDS:** Complete all the steps necessary to establish priorities for the treatment of four casualties.

**PERFORMANCE STEPS:**

1. Assess the situation.
  - a. Sort the casualties and allocate treatment.
    - (1) Assess and classify the casualties for the most efficient use of available medical supplies.
    - (2) Give available treatment first to the casualties who have the best chance of survival.
    - (3) A primary goal is to locate and return to duty troops with minor wounds.
    - (4) Triage establishes the order of treatment, not whether treatment is given.
  - b. Determine the tactical and environment situation.
    - (1) Whether casualties must be transported to a more secure area for treatment.
    - (2) The number and location of the injured and severity of injuries.
    - (3) Available assistance (self-aid, buddy-aid, and medical personnel).
2. Assess the casualties and establish priorities for treatment.
  - a. Immediate. Casualties whose conditions demand immediate treatment to save life, limb, or eyesight. This category has the highest priority.
    - (1) Airway obstruction.
    - (2) Respiratory distress from otherwise treatable injuries.
    - (3) Massive external bleeding.
    - (4) Shock.
    - (5) Burns on the face, neck, hands, feet, genitalia, or perineum.
  - NOTE:** After all life- or limb-threatening conditions have been successfully treated, give no further treatment to the casualty until all other "Immediate" casualties have been treated. Salvage of life takes priority over salvage of limb.
  - b. Delayed. Casualties who have less risk of loss of life or limb if treatment is delayed.
    - (1) Open wounds of the chest without respiratory distress.
    - (2) Open or penetrating abdominal injuries without shock.
    - (3) Severe eye injuries without hope of saving eyesight.
    - (4) Other open wounds.
    - (5) Fractures.
    - (6) Second and third degree burns (not involving the face, neck, hands, feet, genitalia, or perineum) covering 20 percent or more of the total body surface area.
  - c. Minimal. "Walking wounded," may be treated by self-aid or buddy-aid.
    - (1) Minor lacerations and contusions.
    - (2) Sprains and strains.
    - (3) Minor combat stress problems.
    - (4) First or second degree burns (not involving the face, neck, hands, feet, genitalia, or perineum) covering under 20 percent of the total body surface area.
  - d. Expectant. Casualties who are so critically injured that only complicated and prolonged treatment may improve life expectancy. This category is to be used only if resources are limited. If in doubt as to the severity of the injury, place the casualty in one of the other categories.
    - (1) Massive head injuries with signs of impending death.

(2) Burns, mostly third degree, covering more than 85 percent of the total body surface area.

**NOTE:** Provide ongoing supportive care if time and condition permits; keep separate from other triage categorized casualties.

<b>PERFORMANCE MEASURES:</b>	<b>GO</b>	<b>NO GO</b>
1. Assessed the situation.	_____	_____
2. Assessed the casualties and established priorities for treatment.	_____	_____
3. Did not cause further injury to the casualty.	_____	_____

**REFERENCES:**

**Required**

**Related**

FM 4-02

STP 8-91W15-SM-TG, Task No. 081-833-0080

---

Figure 3-23. Triage Casualties On a Conventional Battlefield.

---

## PERFORM A CASUALTY ASSESSMENT

**CONDITIONS:** Given four casualties with conventional injuries.

**STANDARDS:** Assess each casualty, identify all life-threatening injuries, and treat the injuries appropriately per triage priority without causing further injury. Perform the assessments in the correct order.

### PERFORMANCE STEPS:

1. Perform an initial assessment.

**NOTE:** Life-threatening injuries should be treated as they are identified according to casualty triage. If casualty is expectant, move on to next casualty.

a. Assess the casualty's mental status using the AVPU scale.

- (1) A - Alert and oriented.
- (2) V - Responsive to verbal stimuli.
- (3) P - Responsive to painful stimuli.
- (4) U - Unresponsive.

b. Assess the airway.

c. Assess breathing.

d. Assess circulation.

- (1) Skin color, condition, and temperature.
- (2) Assess the pulse for rhythm and force.
- (3) Check for major bleeding.

**NOTE:** The candidate will perform either a rapid trauma assessment (step 2) or a focused assessment (step 3) depending on the casualty's mental status and injuries.

2. Perform a rapid trauma assessment.

a. Head.

(1) Inspect for deformities, contusions, abrasions, punctures or penetration, burns, tenderness, lacerations, swelling (DCAP-BTLS).

(2) Inspect for crepitus.

b. Neck.

- (1) Inspect for DCAP-BTLS.
- (2) Palpate spine step-offs.
- (3) Inspect for jugular vein distention.
- (4) Inspect for tracheal deviation.
- (5) Apply a cervical collar, if necessary.

c. Chest.

- (1) Inspect for DCAP-BTLS.
- (2) Inspect for crepitus.
- (3) Inspect for paradoxical motion.
- (4) Inspect breath sounds (absent/present, equal).

d. Abdomen.

- (1) Inspect for DCAP-BTLS.
- (2) Palpate for tenderness.
- (3) Palpate for rigidity.
- (4) Inspect for distention.

e. Pelvis.

- (1) Inspect for DCAP-BTLS.
- (2) Gently compress to detect instability and crepitus.
- (3) Determine the level of pain.
- (4) Inspect for priapism.

- f. Extremities.
  - (1) Inspect for DCAP-BTLS.
  - (2) Check the distal pulse.
  - (3) Check distal motor function.
  - (4) Check distal sensation.
- g. Posterior.

**NOTE:** The casualty must be log-rolled to do this portion of the assessment.

- (1) Inspect for DCAP-BTLS.
- (2) Inspect for rectal bleeding.
- 3. Perform a focused assessment.
  - a. Perform a focused physical examination of the affected body part.
  - b. Provide interventions and treatment per triage priority.
- 4. Perform ongoing assessment (if time permits).
  - a. Repeat initial assessment.
  - b. Reevaluate interventions/treatments.

**PERFORMANCE MEASURES:**

	<b>GO</b>	<b>NO GO</b>
1. Performed an initial assessment on all casualties.	_____	_____
2. Performed a rapid trauma assessment or focused assessment on all casualties.	_____	_____
3. Did not cause further injury to the casualty.	_____	_____

**REFERENCES:**

**Required**

**Related**

STP 8-91W15-SM-TG, Task No. 081-833-0155  
BTLS FOR PARAMEDICS  
EMERGENCY CARE

---

Figure 3-24. Perform a Casualty Assessment.

---

## CONTROL BLEEDING

**CONDITIONS:** Given a conscious casualty who has a bleeding wound of the arm or leg and the necessary materials to treat the casualty.

**STANDARDS:** Control bleeding by applying field dressing, pressure dressing, and tourniquet without causing further injury to the casualty.

**PERFORMANCE STEPS:**

1. Apply a field dressing to the wound.
  - a. Uncover the wound unless clothing is stuck to it.
  - b. Apply the field dressing.
  - c. Wrap the tails so that the dressing is covered and both sides are sealed.
  - d. Tie a nonslip knot over the outer edge of the dressing, not over the wound.
  - e. Check the tightness of the dressing.
  - f. Check the distal pulse to make sure that the dressing has not been applied too tightly.
  - g. Elevate the affected extremity above the level of the heart.

**CAUTION:** DO NOT ELEVATE IF THERE ARE SUSPECTED MUSCULOSKELETAL INJURIES, IMPALED OBJECTS IN THE EXTREMITY, OR SPINAL INJURY.

2. Apply a pressure dressing if the wound continues to bleed. (Evaluator will state that wound continues to bleed.)
  - a. Place a wad of padding directly over the wound.
  - b. Apply a field dressing or cravat on top of the padding.
  - c. Tie a nonslip knot directly over the wound.
  - d. Check the distal pulse to make sure that the dressing has not been applied too tightly.
  - e. Elevate the affected extremity above the level of the heart.

**CAUTION:** DO NOT ELEVATE IF THERE ARE SUSPECTED MUSCULOSKELETAL INJURIES, IMPALED OBJECTS IN THE EXTREMITY, OR SPINAL INJURY.

3. Apply a tourniquet if the wound continues to bleed. (Evaluator will state that wound continues to bleed.)

**CAUTION:** A TOURNIQUET IS A LAST RESORT FOR LIFE-THREATENING INJURIES. TOURNIQUETS CUT OFF BLOOD FLOW TO AND FROM THE EXTREMITY AND ARE LIKELY TO CAUSE PERMANENT DAMAGE TO VESSELS, NERVES, AND MUSCLES. NEVER LOOSEN OR REMOVE THE TOURNIQUET AFTER IT HAS BEEN APPLIED.

- a. Make a band at least 2 inches wide.
- b. Position the tourniquet 2-4 inches above the edge of the wound but not on a joint.
- c. Tie a half knot.
- d. Place a stick (or similar object) on top of the knot.
- e. Tie a full knot over the stick.
- f. Twist the stick until the tourniquet is tight around the limb and bright red bleeding has stopped.
- g. Secure the stick.
- h. Mark the casualty's forehead with a "T."
- i. Do not cover the tourniquet.
- j. Do not loosen the tourniquet.

**PERFORMANCE MEASURES:**

**GO**      **NO  
GO**

- |  |       |       |
|--|-------|-------|
| 1. Applied a field dressing.                     | _____ | _____ |
| 2. Applied a pressure dressing.                  | _____ | _____ |
| 3. Applied a tourniquet.                         | _____ | _____ |
| 4. Did not cause further injury to the casualty. | _____ | _____ |

**REFERENCES:**

**Required**

**Related**

STP 8-91W15-SM-TG, Task No. 081-833-0161  
BTLS FOR PARAMEDICS  
EMERGENCY CARE

---

Figure 3-25. Control Bleeding.

---

## TREAT A CASUALTY WITH AN OPEN CHEST WOUND

**CONDITIONS:** Given a conscious casualty with an open chest wound and the necessary materials to treat the casualty.

**STANDARDS:** Treat an open chest wound, minimizing the effects of the injury. Seal the entry and exit wounds without causing further injury to the casualty.

**PERFORMANCE STEPS:**

1. Check the casualty for signs and symptoms of an open chest wound.

**NOTE:** Casualty will exhibit one or more of the following signs and symptoms.

- a. A "sucking" or "hissing" sound when the casualty inhales.
- b. Difficulty breathing.
- c. A puncture wound of the chest.
- d. An impaled object protruding from the chest.
- e. Froth or bubbles around the injury.
- f. Coughing up blood or blood-tinged sputum.
- g. Pain in the chest or shoulder.

2. Expose the wound.

- a. Cut or unfasten the clothing that covers the wound.
- b. Disrupt the wound as little as possible.

**NOTE:** Do not remove clothing stuck to the wound.

3. Check for an exit wound.

- a. Feel and/or look at the casualty's chest and back.
- b. Remove the casualty's clothing, if necessary.

4. Seal the wound(s), covering the larger wound first with an occlusive dressing.

**NOTE:** All penetrating chest wounds should be treated as if they were sucking chest wounds.

a. Cut the dressing wrapper on one long and two short sides and remove the dressing.

**NOTE:** In an emergency, any airtight material may be used. It must be large enough so it is not sucked into the chest cavity.

- b. Apply the inner surface of the wrapper to the wound when the casualty exhales.
- c. Ensure that the covering extends at least 2 inches beyond the edges of the wound.
- d. Seal by applying overlapping strips of tape to three sides of the plastic covering to provide a flutter-type valve. The fourth side is not taped and its location is dependent on the position of the casualty.

e. Cover the exit wound in the same way, if applicable.

**NOTE:** Assess the effectiveness of the flutter valve when the casualty breathes. When the casualty inhales, the plastic should be sucked against the wound, preventing the entry of air. When the casualty exhales, trapped air should be able to escape from the wound and out the untaped side of the dressing.

5. Place the casualty in the position of comfort (on the injured side or in a seated position).

**PERFORMANCE MEASURES:**

**GO**      **NO  
GO**

- |   |       |       |
|---|-------|-------|
| 1. Checked the casualty for signs and symptoms of an open chest wound.              | _____ | _____ |
| 2. Exposed the wound.   | _____ | _____ |
| 3. Checked for an exit wound.   | _____ | _____ |
| 4. Sealed the wound(s), covering the larger wound first with an occlusive dressing. | _____ | _____ |
| 5. Placed the casualty in the position of comfort.                                  | _____ | _____ |
| 6. Did not cause further injury to the casualty.                                    | _____ | _____ |

**REFERENCES:**

**Required**

**Related**

STP 8-91W15-SM-TG, Task No. 081-833-0050  
BTLS FOR PARAMEDICS

---

Figure 3-26. Treat a Casualty With an Open Chest Wound.



---

**TREAT A CASUALTY WITH AN OPEN ABDOMINAL WOUND**

**CONDITIONS:** Given a conscious casualty with an open abdominal wound without protruding internal organs and the necessary materials to treat the casualty.

**STANDARDS:** Treat an open abdominal wound, minimizing the effects of the injury, and stabilize the casualty without causing further injury.

**PERFORMANCE STEPS:**

1. Position the casualty.
  - a. Place the casualty on his or her back (face up).
  - b. Flex the casualty's knees after the casualty assessment is completed.
  - c. Turn the casualty's head to the side and keep the airway clear if vomiting occurs.
2. Expose the wound.
3. Apply a sterile abdominal dressing.
  - a. Place the dressing directly on top of the wound.
  - b. Tie the dressing tails loosely in a nonslip knot at the casualty's side.

**CAUTION:** DO NOT APPLY PRESSURE ON THE WOUND OR EXPOSE INTERNAL PARTS.

- c. If two dressings are needed to cover a large wound, repeat steps 3a and 3b. Ensure that the ties of additional dressings are not tied over each other.
  - d. If necessary, loosely cover the dressings with cravats. Tie them on the side of the casualty, opposite that of the dressing ties.
4. Do not cause further injury to the casualty.
  - a. Do not touch any exposed organs with bare hands.
  - b. Do not tie the dressing tails tightly or directly over the dressing.
  - c. Do not give the casualty anything by mouth.
  - d. Do not touch the sterile side of the dressing.

**PERFORMANCE MEASURES:**

	<b>GO</b>	<b>NO GO</b>
1. Positioned the casualty.	_____	_____
2. Exposed the wound.	_____	_____
3. Applied a sterile abdominal dressing.	_____	_____
4. Did not cause further injury to the casualty.	_____	_____

**REFERENCES:**

**Required**

**Related**

STP 8-91W15-SM-TG, Task No. 081-833-0045  
 BTLS FOR PARAMEDICS  
 EMERGENCY CARE

---

Figure 3-27. Treat a Casualty With an Open Abdominal Wound.

---

## IMMOBILIZE A SUSPECTED FRACTURE OF THE ARM

**CONDITIONS:** Given a conscious casualty with a suspected fracture of the arm and the necessary materials to treat the casualty.

**STANDARDS:** Complete all the necessary steps to immobilize a suspected fracture of the arm without causing further injury.

### PERFORMANCE STEPS:

1. Check the casualty's radial pulse. If no pulse is felt, bandage and/or splint the extremity and arrange for immediate evacuation.
2. Position a fractured arm by having the casualty support it with the uninjured arm and hand in the least painful position, if possible.

**CAUTION:** DO NOT TRY TO REDUCE OR SET THE FRACTURE. SPLINT IT WHERE IT LIES.

3. Immobilize the injury. Apply the appropriate treatment depending on the location of the injury.

- a. Use a basswood or an improvised splint for a fractured forearm.

- (1) Pad the splint.

- (2) Place the padded splint under the casualty's forearm so that it extends from the elbow to beyond the fingertips.

- (3) Place a rolled cravat or similar material in the palm of the cupped hand.

- (4) Tie the cravats in a nonslip knot in the following order and recheck the radial pulse after each cravat is applied.

- (a) Above the fracture site near the elbow.

- (b) Below the fracture site near the wrist.

- (c) Over the hand and tied in an "X" around the splint.

- (5) Tie each cravat on the outside edge of the splint.

- (6) Apply an arm sling and swathe.

- b. Use a wire ladder splint for a fractured humerus and for multiple fractures of an arm or a forearm when the elbow is bent.

- (1) Prepare the splint using the uninjured arm for measurements.

- (a) Bend the prong ends of the splint away from the smooth side, about 1 1/2 inches down on the outside of the splint.

- (b) With the smooth side against the elbow, place one end of the splint even with the top of the uninjured shoulder.

- (c) Select a point slightly below the elbow.

- (d) Remove the splint from the arm and bend the splint at the measured point to form an "L."

- (e) Pad the splint.

**NOTE:** If padding is unavailable, apply the splint anyway.

- (2) Position the splint on the outside of the injured arm, extending from the shoulder to beyond the fingertips.

**NOTES:** 1. Extend the "L" angle of the splint beyond, but do not touch, the elbow of the injured arm. Extend the leg of the angle touching the forearm beyond the ends of the fingers. If the splint is too short, extend it with a basswood splint. 2. If possible, have the casualty support the splint.

- (3) Place a rolled cravat or similar material in the palm of the cupped hand.

- (4) Check the radial pulse.

- (5) Tie the cravats in a nonslip knot in the following order and recheck the radial pulse after each cravat is applied.

- (a) On the humerus above any fracture site.

- (b) On the humerus below any fracture site.

- (c) On the forearm above any fracture site.

- (d) On the forearm below any fracture site.

- (e) Around the hand and splint.

(6) Tie each cravat on the outside edge of the splint.

**NOTE:** If the pulse is weaker or absent after tying the cravat, loosen and retie the cravat.

(7) Apply an arm sling and swathe.

c. Use a wire ladder splint for a fractured or dislocated humerus, elbow, or forearm when the elbow is straight.

(1) Prepare the splint.

(2) Position the splint on the outside of the arm against the back of the hand.

(3) Tie the cravats in a nonslip knot in the following order and recheck the radial pulse after each cravat is applied.

(a) Above the injury.

(b) Below the injury.

(c) High on the humerus, above the first cravat.

(d) Around the hand and wrist.

(4) Tie each cravat on the outside of the splint.

**NOTE:** If the pulse is weaker or absent after tying the cravat, loosen and retie the cravat.

(5) Apply swathes.

(a) Place the arm toward the midline in front of the body. Bind the forearm to the pelvic area with a cravat. Tie the knot on the uninjured side.

(b) Apply an additional cravat above the elbow. Secure it on the uninjured side at breast pocket level.

4. Recheck radial pulse.

**PERFORMANCE MEASURES:**

<b>GO</b>	<b>NO GO</b>
-----------	------------------

- |  |       |       |
|--|-------|-------|
| 1. Checked the radial pulse.                     | _____ | _____ |
| 2. Positioned the injury.                        | _____ | _____ |
| 3. Immobilized the injury.                       | _____ | _____ |
| 4. Rechecked radial pulse.                       | _____ | _____ |
| 5. Did not cause further injury to the casualty. | _____ | _____ |

**REFERENCES:**

**Required**

**Related**

STP 8-91W15-SM-TG, Task No. 081-833-0062  
BTLS FOR PARAMEDICS

---

Figure 3-28. Immobilize a Suspected Fracture of the Arm.

---

**INITIATE TREATMENT FOR HYPOVOLEMIC SHOCK**

**CONDITIONS:** Given a conscious casualty who is suffering from a severe loss of body fluids and the necessary materials to initiate treatment for hypovolemic shock.

**STANDARDS:** Initiate treatment for hypovolemic shock, stabilize the casualty, and minimize the effect of shock without causing further injury to the casualty.

**PERFORMANCE STEPS:**

**NOTE:** Hypovolemic shock results when there is a decrease in the volume of circulating fluids (blood and plasma) in the body. If dehydration (loss of body water) is present at the time of injury, shock will develop more rapidly.

1. Reassure the casualty to reduce anxiety.

**NOTE:** Anxiety increases the heart rate, which worsens the casualty's condition.

2. Initiate two large bore (16 gauge) IVs. (Initiate one large bore IV for EFMB purposes.) (See task "Initiate an Intravenous (IV) Infusion," Figure 3-31.)

3. Elevate the casualty's legs above chest level, without lowering the head below chest level.

4. Maintain normal body temperature. (The casualty will exhibit symptoms of being hot or cold.)

a. Watch for signs of sweating or chilling.

b. Cover the casualty in cold weather.

c. Do not cover the casualty in hot weather unless signs of chilling are noted. Loosen restrictive clothing and provide shade, if available.

5. Monitor the casualty every 5-15 minutes.

**NOTE:** Give nothing by mouth.

**PERFORMANCE MEASURES:**

<b>GO</b>	<b>NO GO</b>
-----------	------------------

1. Reassured the casualty to reduce anxiety.

_____	_____
-------	-------

2. Initiated one large bore IV.

_____	_____
-------	-------

NOTE: Performance steps for this task will be evaluated under the task, "Initiate an Intravenous Infusion."

3. Elevated the casualty's legs.

_____	_____
-------	-------

4. Maintained normal body temperature.

_____	_____
-------	-------

5. Monitored the casualty every 5-15 minutes.

_____	_____
-------	-------

6. Did not cause further injury to the casualty.

_____	_____
-------	-------

**REFERENCES:**

**Required**

**Related**

STP 8-91W15-SM-TG, Task No. 081-833-0047  
 BTLS FOR PARAMEDICS  
 EMERGENCY CARE

---

Figure 3-29. Initiate Treatment For Hypovolemic Shock.

---

**TREAT A CASUALTY WITH AN OPEN HEAD INJURY**

**CONDITIONS:** Given a conscious casualty with an open head injury and the necessary materials to treat the head injury.

**STANDARDS:** Treat the casualty by covering the wound with a field dressing without contaminating the wound or causing further injury to the casualty.

**PERFORMANCE STEPS:**

1. Assess the casualty's pupil size.
  - a. Observe the size of each pupil.

**NOTE:** A variation of pupil size may indicate a brain injury. In a very small percentage of people, unequal pupil size is normal.

- b. Shine a light into each eye to observe the pupillary reaction to light.

**NOTES:** 1. The candidate will not turn the pin light on. The evaluator will state to the candidate the condition of the pupils. 2. The pupils should constrict promptly when exposed to bright light. Failure of the pupils to constrict may indicate brain injury.

2. Assess the casualty's motor function. Evaluate the casualty's strength, mobility, coordination, and sensation.

**NOTE:** Progressive loss of strength or sensation is an important indicator of brain injury.

3. Position the casualty.
4. Treat the head injury.
  - a. Expose the wound.
  - b. Apply the dressing to the wound.
  - c. Tie the tails with a nonslip knot.
5. Monitor the casualty at 15-minute intervals.

**PERFORMANCE MEASURES:**

1. Assessed the casualty's pupil size.
2. Assessed the casualty's motor function.
3. Positioned the casualty.
4. Treated the head injury.
5. Continued to monitor the casualty at 15-minute intervals.
6. Did not cause further injury to the casualty.

<b>GO</b>	<b>NO GO</b>
_____	_____
_____	_____
_____	_____
_____	_____
_____	_____
_____	_____

**REFERENCES:**

**Required**

**Related**

STP 8-91W15-SM-TG, Task No. 081-831-0018  
 STP 8-91W15-SM-TG, Task No. 081-833-0052  
 BTLS FOR PARAMEDICS  
 EMERGENCY CARE

---

Figure 3-30. Treat a Casualty With an Open Head Injury.

---

## INITIATE AN IV INFUSION

**CONDITIONS:** Given a conscious casualty with a need for fluid replacement treatment and the necessary materials to establish an IV infusion.

**STANDARDS:** Initiate an IV infusion without causing further injury to the casualty.

**PERFORMANCE STEPS:**

1. Explain to the casualty what is going to be done.
2. Assemble and inspect the IV injection set for defects, expiration date, and contamination.
  - a. Spike, drip chamber, tubing, and needle adapter. Discard them if there are cracks or holes or if any discoloration is present.
  - b. Tubing clamp. Ensure that the clamp releases and catches.
  - c. Needle or catheter-over-needle. Discard them if they are flawed with barbs or nicks.
3. Prepare the equipment.
  - a. Clamp the tubing 6 to 8 inches below the drip chamber.
  - b. Remove the protective covers from the spike and from the outlet of the IV container.

**CAUTION:** DO NOT TOUCH THE SPIKE OR THE OUTLET OF THE IV CONTAINER.

- c. Insert the spike into the container.
- d. Hang the container at least 2 feet above the level of the casualty's heart, if possible.

**NOTE:** An IV bag container may be placed under the casualty's body if there is no way to hang it.

- e. Squeeze the drip chamber until it is half full of the IV fluid.
- f. Prime the tubing.

**NOTE:** Ensure that all air is expelled from the tubing.

- (1) Hold the tubing above the level of the bottom of the container.
- (2) Loosen the protective cover from the needle adapter to allow the air to escape.
- (3) Release the clamp on the tubing.
- (4) Gradually lower the tubing until the solution reaches the end of the needle adapter.
- (5) Clamp the tubing.
- (6) Retighten the needle adapter's protective cover.
- (7) Loop the tubing over the IV stand or holder.
- g. Cut several pieces of tape and hang them in a readily accessible place.

4. Select the infusion site.

**NOTE:** The candidate will initiate the infusion using a practice device.

- a. Choose the most distal and accessible vein of an uninjured arm or hand.
- b. Avoid sites over joints.
- c. Avoid veins in infected, injured, or irritated areas.
- d. Use the nondominant hand or arm, whenever possible.

**CAUTION:** DO NOT USE AN ARM THAT MAY REQUIRE AN OPERATIVE PROCEDURE.

- e. Select a vein large enough to accommodate the size of needle/catheter to be used.

5. Prepare the infusion site.

- a. Apply the constricting band.

**NOTE:** When applying the constricting band, use soft-walled latex tubing about 18 inches in length.

(1) Place the tubing around the limb, about 2 inches above the site of venipuncture. Hold one end so that it is longer than the other, and form a loop with the longer end.

(2) Pass the looped end under the shorter end of the constricting band.

**NOTE:** When placing the constricting band, ensure that the tails of the tubing are turned away from the proposed site of venipuncture.

(3) Apply the constricting band tight enough to stop venous flow but not so tightly that the radial pulse cannot be felt.

(4) Tell the casualty to open and close his or her fist several times to increase circulation.

**CAUTION:** DO NOT LEAVE THE CONSTRICTING BAND IN PLACE FOR MORE THAN 2 MINUTES.

b. Tell the casualty to close his or her fist and keep it closed until instructed to open the fist.

c. Clean the skin over the selected area with 70 percent alcohol, using a firm circular motion from the center outward.

d. Allow the skin to dry and discard the pad.

6. Prepare to puncture the vein.

a. Pick up the assembled needle and remove the protective cover with the other hand.

(1) Ensure that the needle is bevel up.

(2) Place the forefinger on the needle hub to guide it during insertion through the skin and into the vein.

b. Position yourself so as to have a direct line of vision along the axis of the vein to be entered.

7. Puncture the vein (into the practice device).

**CAUTION:** KEEP THE NEEDLE AT THE SAME ANGLE TO PREVENT THROUGH-AND-THROUGH PENETRATION OF THE VEIN WALLS.

**NOTE:** You may position the needle directly above the vein or slightly to one side of the vein.

a. Draw the skin below the cleaned area downward to hold the skin taut over the site of venipuncture.

b. Position the needle point, bevel up, parallel to the vein and about 1/2 inch below the site of venipuncture.

c. Hold the needle at a 20- to 30-degree angle and insert it through the skin.

d. Decrease the angle of the needle until it is almost parallel to the skin surface and direct it toward the vein.

e. Move the needle forward about 1/2 inch into the vein.

8. Confirm the puncture.

**NOTE:** A faint "give" will be felt as the needle enters the lumen of the vein.

a. Check for blood in the flash chamber. If successful, proceed to step 9.

b. If the venipuncture is unsuccessful, pull the needle back slightly (not above the skin surface) and attempt to pierce the vein again.

9. Advance the needle or the catheter.

a. Grasp the hub and advance the needle into the vein up to the hub.

b. If using the catheter-over-needle, grasp the hub and with a slight twisting motion fully advance the catheter.

c. While continuing to hold the hub, press lightly on the skin over the needle or catheter tip with the fingers of the other hand.

**NOTE:** This prevents the backflow of blood from the hub.

d. If using a catheter-over-needle, remove the needle from inside the catheter.

10. Remove the protective cover from the needle adapter on the tubing. Quickly and tightly connect the adapter to the catheter or needle hub.

**WARNING:** DO NOT ALLOW AIR TO ENTER THE BLOOD STREAM.

11. Tell the casualty to unclench the fist, and then release the constricting band.
12. Unclamp the IV tubing and adjust the flow rate to keep the vein open.
13. Check the site for infiltration. If it is painful, swollen, red, cool to the touch, or if fluid is leaking from the site, stop the infusion immediately.
14. Secure the site.
  - a. Apply a sterile 2- x 2-inch dressing over the puncture site and secure it with tape, leaving the hub and tubing connection visible.
  - b. Loop the IV tubing onto the extremity and secure the loop with tape.
  - c. Splint the arm loosely on a padded splint, if necessary, to reduce movement.

**NOTE:** The candidate will only state that he or she would splint the arm, if using antecubital fossa.

15. Readjust the flow rate.
16. Recheck the site for infiltration.

**PERFORMANCE MEASURES:**

	<b>GO</b>	<b>NO GO</b>
1. Explained to the casualty what is going to be done.	_____	_____
2. Inspected the IV set.	_____	_____
3. Prepared the equipment.	_____	_____
4. Selected the infusion site.	_____	_____
5. Prepared the infusion site.	_____	_____
6. Prepared to puncture the vein.	_____	_____
7. Punctured the vein (into the practice device).	_____	_____
8. Confirmed the puncture.	_____	_____
9. Advanced the needle or the catheter.	_____	_____
10. Connected the tubing to the catheter or needle hub.	_____	_____
11. Released the constricting band.	_____	_____
12. Unclamped the IV tubing and adjusted the flow rate.	_____	_____
13. Checked the site for infiltration.	_____	_____
14. Secured the site.	_____	_____
15. Readjusted the flow rate.	_____	_____
16. Rechecked the site for infiltration.	_____	_____
17. Did not cause further injury to the casualty.	_____	_____

**REFERENCES:**

**Required**

**Related**

STP 8-91W15-SM-TG, Task No. 081-833-0033  
BASIC NURSING

---

Figure 3-31. Initiate an IV Infusion.



---

## INITIATE A U.S. FIELD MEDICAL CARD

**CONDITIONS:** Given four treated casualties and a blank DD Form 1380 (U.S. Field Medical Card).

**STANDARDS:** Complete, as a minimum, blocks 1, 3, 4, 7, 9, and 11 for each casualty. Complete blocks 2, 5, 6, 8, 10, 12, 13, 14, 15, 16, and 17 as appropriate. Complete other blocks as time permits.

### PERFORMANCE STEPS:

1. Remove the protective sheet from the carbon copy.  
 2. Complete the minimum required blocks.  
 a. Block 1. Enter the casualty's name, rank, and complete social security number (SSN). If the casualty is a foreign military person (including prisoners of war), enter his or her military service number. Enter the casualty's MOS or AOC for specialty code. Enter the casualty's religion and sex.

b. Block 3. Use the figures in the block to show the location of the injury or injuries. Check the appropriate box(es) to describe the casualty's injury or injuries.

**NOTES:** 1. When more space is needed, attach another DD Form 1380 to the original. Label the second card in the upper right corner "DD Form 1380 #2." It will show the casualty's name, grade, and SSN. 2. Use only authorized abbreviations. Except for those listed below, abbreviations may not be used for diagnostic terminology.

Abr W - Abraded wound.

Cont W - Contused wound.

FC - Fracture (compound) open.

FCC - Fracture (compound) open comminuted.

FS - Fracture (simple) closed.

LW - Lacerated wound.

MW - Multiple wounds.

Pen W - Penetrating wound.

Perf W - Perforating wound.

SL - Slight.

SV - Severe.

c. Block 4. Check the appropriate box.

d. Block 7. Check the yes or no box. Write in the dose administered and the date and time that it was administered.

e. Block 9. Write in the information requested. If you need additional space, use Block 14.

f. Block 11. Initial the far right side of the block.

3. Complete the other blocks as time permits. Most blocks are self-explanatory. The following specifics are noted:

a. Block 2. Enter the casualty's unit of assignment and the country of whose armed forces he or she is a member. Check the armed service of the casualty, that is, A/T = Army, AF/A = Air Force, N/M = Navy, and MC/M Marine.

b. Block 5. Write in the casualty's pulse rate and the time that the pulse was measured.

c. Block 6. Check the yes or no box. If a tourniquet is applied, you should write in the time and date it was applied.

d. Block 8. Write in the time, date, and type of IV solution given. If you need additional space, use Block 9.

e. Block 10. Check the appropriate box. Write in the date and time of disposition.

- f. Block 12. Write in the time and date of the casualty's arrival. Record the casualty's blood pressure, pulse, and respirations in the space provided.
  - g. Block 13. Document the appropriate comments by the date and time of observation.
  - h. Block 14. Document the provider's orders by date and time. Record the dose of tetanus administered and the time it was administered. Record the type and dose of antibiotic administered and the time it was administered.
  - i. Block 15. The signature of the provider or medical officer is written in this block.
  - j. Block 16. Check the appropriate box and enter the date and time.
  - k. Block 17. This block will be completed by the United Ministry Team. Check the appropriate box of the service provided. The signature of the chaplain providing the service is written in this block.
4. Attach the completed Field Medical Card to the casualty.

**PERFORMANCE MEASURES:**

<b>GO</b>	<b>NO GO</b>
-----------	------------------

- |  |       |       |
|--|-------|-------|
| 1. Removed the protective sheet from the carbon copy.              | _____ | _____ |
| 2. As a minimum, correctly completed blocks 1, 3, 4, 7, 9, and 11. | _____ | _____ |
| 3. Completed the forms and tagged each casualty.                   | _____ | _____ |

**REFERENCES:**

**Required**

**Related**

AR 40-66

STP 8-91W15-SM-TG, Task No. 081-831-0033

---

Figure 3-32. Initiate a U.S. Field Medical Card.

### **3-14. EVACUATION OF THE SICK AND WOUNDED TASKS.**

a. Objective. To measure the candidate's ability to evacuate casualties using manual carries, medical devices, tactical vehicles, and aircraft in a battlefield scenario.

b. Requirements. The candidate is required to complete eight of the nine performance tasks listed below and pass six of the eight. The test board chairperson will determine if paragraph 3-14c(4) or 3-14c(5) is tested. The tasks are tested in a simulated battlefield scenario with the required equipment IAW paragraphs 3-5 and 3-6.

(1) The host unit will not establish a combat lane with all evacuation tasks on it. Two or more tactical vehicles are not permitted on the same combat lane.

(2) The host unit will train the candidates on the 4-person carry position and the commands to lift, move, load, and lower the litter.

(3) Candidates will serve as the number 1 litter bearer when loading casualties onto a tactical vehicle or aircraft. He or she does not have to be in the number 1 position but may position the litter bearers to best utilize the litter squad's strengths. All commands and directions will be given by the candidate to the litter bearers.

(4) Candidates will not be used as a casualty at any time during test week.

(5) Candidates will not be used as part of the litter bearer squad to load a tactical vehicle or aircraft except when they are being tested.

(6) Casualties will weigh between 140 and 180 pounds (63.56 and 81.72 kilograms). Mannequins or sandbags will not be used.

c. Tasks. The following tasks are tested using reaction-style testing.

(1) Establish a helicopter landing point (Figure 3-33).

(2) Load casualties onto a UH-60 helicopter (Figure 3-34).

(3) Load casualties onto ground evacuation platform (M996, M997, or M113) (Figure 3-35).

(4) Load casualties onto nonstandard vehicle (5-ton M-1085, M-1093, or 2 1/2-ton M-1081) (Figure 3-36).

(5) Load casualties onto nonstandard vehicle (2 1/2-ton, 6x6 or 5-ton, 6x6, cargo truck) (Figure 3-37).

(6) Load casualties onto nonstandard vehicle (1 1/4-ton, 4x4, M998) (Figure 3-38).

(7) Prepare to transport a casualty with a suspected spinal injury (Figure 3-39).

(8) Transport a casualty using the fireman's carry (Figure 3-40).

(9) Transport a casualty using the cradle drop drag (Figure 3-41).

- d. Equipment. Host unit will provide all equipment and supplies for evacuation tasks at the tested sites.
- e. Changes. Changes are NOT authorized without an exception to policy approval.

## ESTABLISH A HELICOPTER LANDING POINT

**CONDITIONS:** Given strobe lights, flashlights or vehicle lights, marker panels, and an area to be prepared for the landing site.

**STANDARDS:** The site is large enough for a helicopter to land and take off. All obstacles that cannot be removed are marked or identified and the touchdown point on the landing site is identified.

### PERFORMANCE STEPS:

1. Select the landing site. (State the four factors and considerations for each to the evaluator.)

a. The size of the landing site.

(1) A helicopter requires a relatively level landing area 30 meters in diameter. This does not mean that a loaded helicopter can land and take off from an area of that size. Most helicopters cannot go straight up or down when fully loaded; therefore, a larger landing site and better approach and departure routes are required.

(2) When obstacles are in the approach or departure routes, a 10 to 1 ratio must be used to lay out the landing site (Figure 3-33a). For example, during the approach and departure, if the helicopter must fly over trees that are 15 meters high, the landing site must be at least 150 meters long ( $10 \times 15 = 150$  meters).

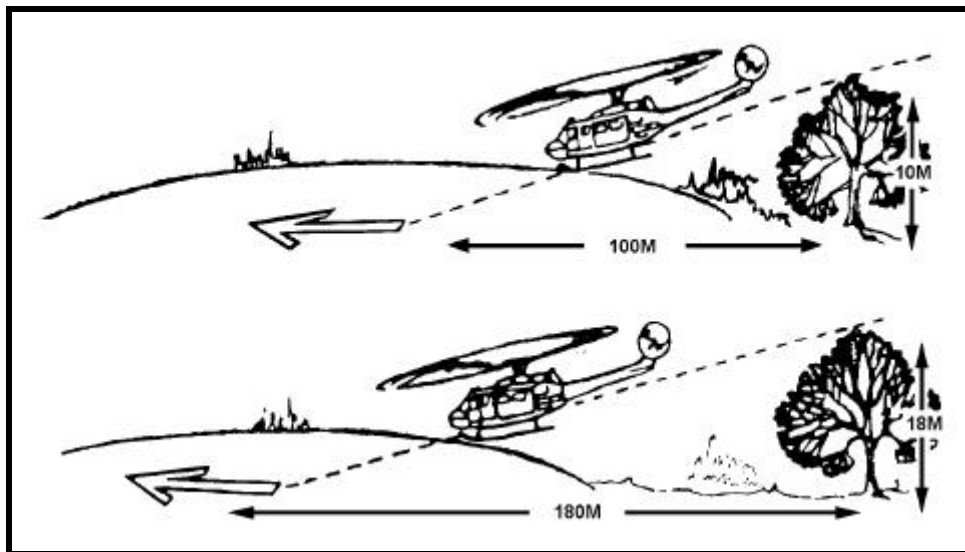

Figure 3-33a. Obstacles in the Approach or Departure Route.

b. The ground slope of the landing site. When selecting the landing site, the ground slope must be no more than 15 degrees. Helicopters cannot safely land on a slope of more than 15 degrees.

(1) When the ground slope is under 7 degrees, the helicopter should land upslope.

(2) When the ground slope is 7 to 15 degrees, the helicopter must land sideslope.

c. Surface conditions.

(1) The ground must be firm enough that the helicopter does not bog down during loading or unloading. If firm ground cannot be found, the pilot must be told. He may hover at the landing site during the loading or unloading.

(2) Rotor wash on dusty, sandy, or snow-covered surfaces may cause loss of visual contact with the ground; therefore, these areas should be avoided.

(3) Loose debris that can be kicked up by the rotor wash must be removed from the landing site. Loose debris can cause damage to the blades or engines.

d. Obstacles.

(1) Landing sites should be free of tall trees, telephone lines, power lines or poles, and similar obstructions on the approach or departure ends of the landing site.

(2) Obstructions that cannot be removed (such as large rocks, stumps, or holes) must be marked clearly within the landing site.

2. Remove all obstacles and debris at the landing site and mark obstructions that cannot be removed. Ensure that the marker is properly secured to the obstacle or ground.

3. Mark the landing site and identify the touchdown point.

**NOTE:** For EFMB testing purposes, only step 3b will be performed with strobe lights during daylight hours.

a. When and how the landing site should be marked is based on the mission, capabilities, and situation of the unit concerned. Normally, the only mark or signals required are smoke (colored) and a signalman. VS-17 marker panels may be used to mark the landing site, but **MUST NOT** be used any closer than 50 feet to the touchdown point. In addition to identifying the landing site, smoke gives the pilot information on the wind direction and speed.

b. An inverted "Y," composed of four lights, marks the landing site and touchdown point at night (Figure 3-33b). Strobe lights, flashlights, or vehicle lights may also be used to mark the landing site. The marking system used will be fully explained to the pilot when contact is made.

**NOTE:** The candidate will state to the evaluator the marking system used and identify the touchdown point once he or she completes marking the landing site.

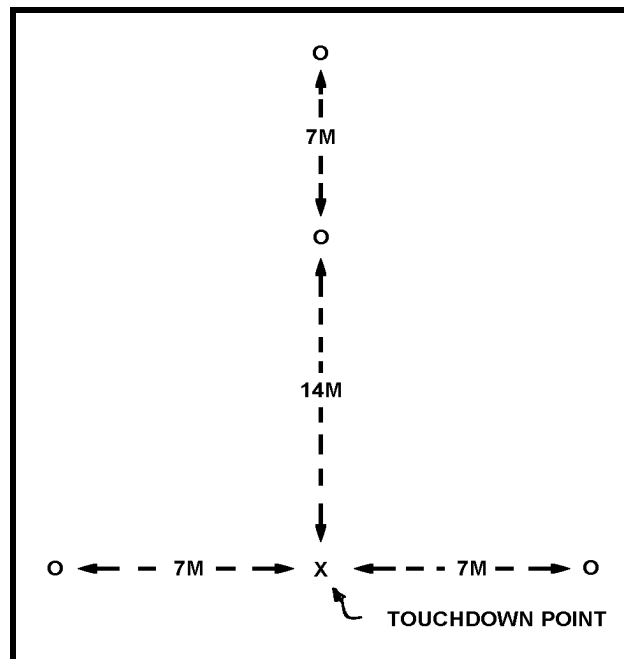

Figure 3-33b. Night Landing Site.

**PERFORMANCE MEASURES:**

**GO**    **NO  
GO**

- |  |       |       |
|--|-------|-------|
| 1. Selected the landing site (stated the four factors and considerations for each).    | _____ | _____ |
| 2. Removed all obstacles and debris and marked obstructions that could not be removed. | _____ | _____ |
| 3. Marked the landing site and identified the touchdown point.                         | _____ | _____ |

**REFERENCES:**

**Required**

**Related**

FM 7-8

FM 21-60

FM 3-21.38

STP 8-91W15-SM-TG, Task No. 071-334-4002

---

Figure 3-33. Establish a Helicopter Landing Point.

---

## LOAD CASUALTIES ONTO A UH-60 HELICOPTER

**CONDITIONS:** Given a UH-60 helicopter, three treated casualties, and three litters with straps. You and three noncandidate soldiers will form a litter squad, with you serving as the number 1 person to load the casualties. The flight crew has configured the aircraft to receive the casualties.

**STANDARDS:** Prioritize, load, and secure three casualties onto a UH-60 helicopter within 20 minutes, in the proper sequence, without causing further injury to the casualties.

### PERFORMANCE STEPS:

1. Survey the casualties to determine loading sequence.

**NOTE:** Time starts when the candidate starts surveying the casualties or starts the steps to secure the casualties onto the litters.

a. Position litter casualties in the helicopter according to the nature of their injuries or condition.

b. Load the most seriously injured casualties last on the bottom pans of the litter support unit. However, if in-flight emergency medical care may be required, such as cardiopulmonary resuscitation, load the casualty onto either of the top pans to facilitate access.

c. Load casualties receiving IV fluids or oxygen on any litter pan, depending on their injuries or condition (if applicable).

d. Load casualties in traction splints last on a bottom pan (if applicable).

2. Under the supervision of the flight personnel, serve as the number 1 position and with the assistance of the noncandidate soldiers—

a. Secure the three casualties onto the litters.

b. Move the litter to the aircraft.

**NOTE:** The UH-60 can be loaded on both sides. Load the casualty so that upon rotating the litter support, his or her head will be forward in the cabin.

**WARNING:** DO NOT APPROACH THE AIRCRAFT UNTIL THE FLIGHT CREW DIRECTS YOU TO DO SO.

c. Load litters onto litter pans.

(1) If loading from one side of the aircraft with the carousel turned, the sequence is upper right, upper left, lower right, and then lower left.

(2) If loading from both sides of the aircraft simultaneously, the sequence is upper then lower.

(3) Direct the litter squad to move into the semioverhead carry, lifting the litter just high enough for the litter stirrups of one end to slide onto the litter pan.

(4) Direct the litter squad to slide the litter forward until the litter stirrups of both ends are secured on the pan. The candidate raises the pan back to its upright position and secures it and the litter.

**NOTE:** The litter team may assist the candidate in securing the pan and the litter but it is still the candidate's responsibility to ensure that the pan and litter are secured properly.

**WARNING:** THE LITTER SQUAD DEPARTS ONLY WHEN DIRECTED TO DO SO BY THE FLIGHT CREW.

3. Load the remaining casualties IAW steps 2b and 2c.

**NOTE:** Time ends when the litter squad departs the aircraft after loading and securing the last litter.



**PERFORMANCE MEASURES:**

**GO**      **NO  
GO**

- |   |       |       |
|---|-------|-------|
| 1. Surveyed the casualties to determine loading sequence.                               | _____ | _____ |
| 2. Served as the number 1 person, giving the appropriate commands to the litter squad.  | _____ | _____ |
| 3. Secured the three casualties onto the litters and moved the litters to the aircraft. | _____ | _____ |
| 4. Loaded litters onto litter pans.   | _____ | _____ |
| 5. Loaded all litters in the proper sequence.   | _____ | _____ |
| 6. Secured the casualties for transport.  | _____ | _____ |
| 7. Approached and departed the aircraft when directed by the flight crew.               | _____ | _____ |
| 8. Did not cause further injury to the casualties.                                      | _____ | _____ |
| 9. Correctly performed all performance measures within 20 minutes.                      | _____ | _____ |

**REFERENCES:**

**Required**

**Related**  
FM 8-10-6

---

Figure 3-34. Load Casualties Onto a UH-60 Helicopter.

---

**LOAD CASUALTIES ONTO GROUND EVACUATION PLATFORM  
(M996, M997, OR M113)**

**CONDITIONS:** Given an unconfigured ground evacuation platform, three treated casualties, and two litters with straps. You and three noncandidate soldiers will form a litter squad, with you serving as the number 1 person to load the casualties.

**STANDARDS:** Configure the vehicle properly. Prioritize, load, and secure three casualties (two litter and one ambulatory) within 15 minutes, in the proper sequence, without causing further injury to the casualties.

**PERFORMANCE STEPS:**

1. Survey the casualties to determine loading sequence.

**NOTE:** Time starts when the candidate starts surveying the casualties, starts the steps to secure the casualties onto the litters, or starts the steps to configure the vehicle.

a. Casualties are normally loaded head first. They are less likely to experience motion sickness or nausea with the head in the direction of travel. When en route, if care is required for an injury on one side, it may be necessary to load feet first to access the casualty from the aisle.

b. Casualties with wounds of the chest or abdomen or those receiving IV fluids are loaded in lower berths to provide gravity flow.

c. Casualties wearing bulky splints should be placed on lower berths.

2. Secure the two litter casualties onto the litters.

**NOTE:** The candidate may direct the noncandidates to secure the casualties while he or she configures and prepares the vehicle. However, it is still the candidate's responsibility to ensure that the casualties are properly secured to the litters.

3. Configure and prepare the vehicle properly to receive the casualties (two litter and 1 ambulatory). Remove any debris and trash.

4. Serve as the number 1 person and, with the assistance of the noncandidate soldiers, move the litters to the vehicle.

5. Load the casualties, in the proper sequence, onto the vehicle.

a. M996.

(1) Load the litter head first in the right berth and then left.

(2) Instruct the ambulatory casualty to sit in the aisle or tailgate seat.

b. M997 and M113.

(1) Load the litter head first in the upper right berth and then lower right.

(2) Instruct the ambulatory casualty to sit on the left side of the vehicle.

6. Secure the casualties for transport.

**NOTE:** The noncandidate soldiers may assist the candidate by securing the litters onto the litter racks. However, it is still the candidate's responsibility to ensure that the litters are properly secured.

7. Fold and stow the litter rail extension (if applicable).

8. Close the door and secure the latch.

**NOTE:** Time ends when the door is secured.

**PERFORMANCE MEASURES:**

1. Surveyed the casualties to determine loading sequence.

GO	NO GO
_____	_____
_____	_____

2. Secured the two litter casualties onto the litters.

**PERFORMANCE MEASURES:**

**GO**      **NO  
GO**

- |  |       |       |
|--|-------|-------|
| 3. Configured and prepared the vehicle properly to receive the casualties.             | _____ | _____ |
| 4. Served as the number 1 person, giving the appropriate commands to the litter squad. | _____ | _____ |
| 5. Loaded the casualties in the proper sequence.                                       | _____ | _____ |
| 6. Secured the casualties for transport.   | _____ | _____ |
| 7. Folded and stowed the litter rail extension (if applicable).                        | _____ | _____ |
| 8. Closed the door and secured the latch.  | _____ | _____ |
| 9. Did not cause further injury to the casualties.                                     | _____ | _____ |
| 10. Correctly performed all performance measures within 15 minutes.                    | _____ | _____ |

**REFERENCES:**

**Required**

**Related**  
FM 8-10-6

---

Figure 3-35. Load Casualties Onto Ground Evacuation Platform (M996, M997, or M113).

## LOAD CASUALTIES ONTO NONSTANDARD VEHICLE (5-TON M-1085, M-1093, OR 2 1/2-TON M-1081)

**CONDITIONS:** Given an unconfigured, nonstandard vehicle (without bow and canvas), five treated casualties, and five litters with straps and cravats. You and three noncandidate soldiers will form a litter squad, with you serving as the number 1 person to load the casualties.

**STANDARDS:** Configure the vehicle properly. Prioritize, load, and secure five casualties within 20 minutes, in the proper sequence, without causing further injury to the casualties.

**PERFORMANCE STEPS:**

1. Survey the casualties to determine loading sequence.

**NOTE:** Time starts when the candidate starts surveying the casualties, starts the steps to secure the casualties onto the litters, or starts the steps to configure the vehicle.

2. Secure the five casualties onto the litters.

**NOTE:** The candidate may direct the noncandidates to secure the casualties while he or she configures and prepares the vehicle. However, it is still the candidate's responsibility to ensure that the casualties are properly secured to the litters.

3. Serve as the number 1 person and, with the assistance of the noncandidate soldiers, move the litters to the vehicle.

4. Configure and load an M-1085 (Figure 3-36a).

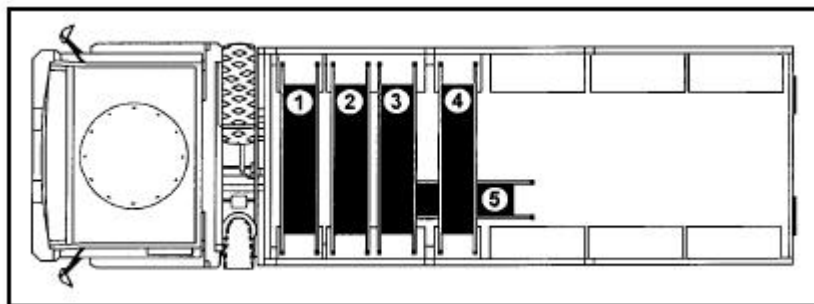

Figure 3-36a. M-1085 Configuration.

a. Lower the seats and secure the vertical support brackets in place. Remove any debris and trash.

b. Place four litters (litter numbers 1 through 4) crosswise on the seats, forward, next to the cab. Secure the litters individually to the seats with cravats using nonslip knots.

**NOTES:** 1. Casualties may be loaded either head to head or head to toe. 2. The noncandidate soldiers may assist the candidate by securing the litters to the vehicle. However, it is still the candidate's responsibility to ensure that the litters are properly secured.

c. Place one litter (litter number 5) lengthwise on the floor, forward toward the cab, feet first, ensuring that the patients' head is exposed from under the upper litters. Secure the litter to the vertical seat supports with cravats using nonslip knots.

5. Configure and load an M-1093 (Figure 3-36b).

a. Lower the seats and secure the vertical support bracket into place. Remove any debris and trash.

b. Place three litters (litter numbers 1 through 3) crosswise on the seats, forward, next to the cab. Secure the litters individually to the seats with cravats using nonslip knots.

**NOTES:** 1. Casualties may be loaded either head to head or head to toe. 2. The noncandidate soldiers may assist the candidate by securing the litters to the vehicle. However, it is still the candidate's responsibility to ensure that the litters are properly secured.

c. Place two litters (litter numbers 4 and 5) lengthwise on the floor, forward toward the cab, feet first. Secure the litters together and to the vertical seat support with cravats using nonslip knots.

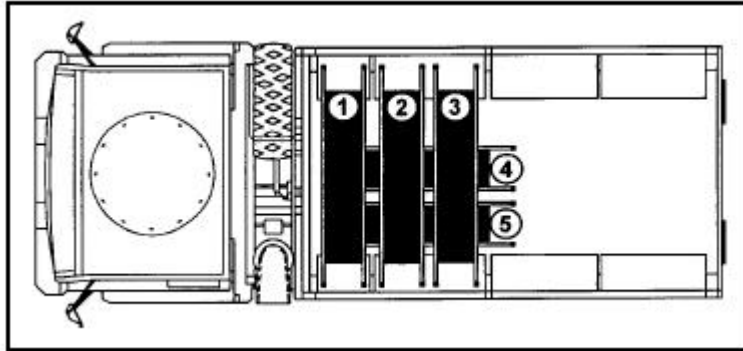

Figure 3-36b. M-1093 Configuration.

6. Configure and load an M-1081 (Figure 3-36c).

a. Lower the seats and secure the vertical support bracket into place. Remove any debris and trash.

b. Place three litters (litter numbers 1 through 3) crosswise on the seats, forward, next to the cab. Secure the litters individually to the seats with cravats using nonslip knots.

**NOTES:** 1. Casualties may be loaded either head to head or head to toe. 2. The noncandidate soldiers may assist the candidate by securing the litters to the vehicle. However, it is still the candidate's responsibility to ensure that the litters are properly secured.

c. Place two litters (litter numbers 4 and 5) lengthwise on the floor, forward toward the cab, feet first. Secure the litters together and to the vertical seat support with cravats using nonslip knots.

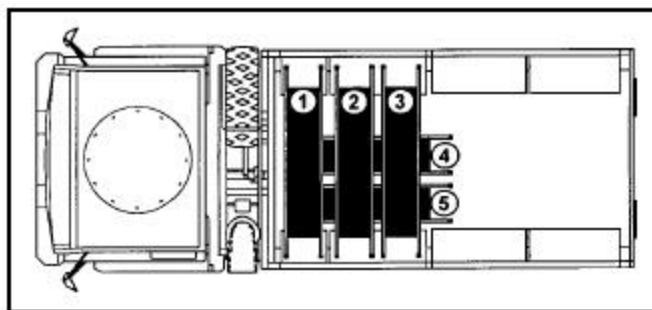

Figure 3-36c. M-1081 Configuration.

7. Raise and secure the tailgate.

**NOTE:** Time ends when the tailgate is secured.

**PERFORMANCE MEASURES:**

**GO**    **NO  
GO**

- |  |       |       |
|--|-------|-------|
| 1. Surveyed the casualties to determine loading sequence.                              | _____ | _____ |
| 2. Secured the five casualties onto the litters.                                       | _____ | _____ |
| 3. Served as the number 1 person, giving the appropriate commands to the litter squad. | _____ | _____ |
| 4. Configured and prepared the vehicle to receive casualties.                          | _____ | _____ |
| 5. Loaded the casualties in the proper sequence.                                       | _____ | _____ |
| 6. Secured the casualties for transport.   | _____ | _____ |
| 7. Raised and secured the tailgate.  | _____ | _____ |
| 8. Did not cause further injury to the casualties.                                     | _____ | _____ |
| 9. Correctly performed all performance measures within 20 minutes.                     | _____ | _____ |

**REFERENCES:**

**Required**

**Related**

FM 8-10-6

STP 8-91W15-SM-TG, Task No. 081-833-0173

---

Figure 3-36. Load Casualties Onto Nonstandard Vehicle  
(5-Ton M-1085, M-1093, or 2 1/2-Ton M-1081).

**LOAD CASUALTIES ONTO NONSTANDARD VEHICLE  
(2 1/2-TON, 6X6 OR 5-TON, 6X6, CARGO TRUCK)**

**CONDITIONS:** Given an unconfigured, nonstandard vehicle (without bow and canvas), five treated casualties, and five litters with straps and cravats. You and three noncandidate soldiers will form a litter squad, with you serving as the number 1 person to load the casualties.

**STANDARDS:** Configure the vehicle properly. Prioritize, load, and secure five casualties within 20 minutes, in the proper sequence, without causing further injury to the casualties.

**PERFORMANCE STEPS:**

1. Survey the casualties to determine loading sequence.

**NOTE:** Time starts when the candidate starts surveying the casualties, starts the steps to secure the casualties onto the litters, or starts the steps to configure the vehicle.

2. Secure the five casualties onto the litters.

**NOTE:** The candidate may direct the noncandidates to secure the casualties while he or she configures and prepares the vehicle. However, it is still the candidate's responsibility to ensure that the casualties are properly secured to the litters.

3. Serve as the number 1 person and, with the assistance of the noncandidate soldiers, move the litters to the vehicle.

4. Configure and load the vehicle.

a. Lower the seats. Remove any debris and trash.

b. Place three litters crosswise on the seats, as far forward as possible, and two litters lengthwise, in the bed of the truck, as far forward as possible.

**NOTES:** 1. Casualties may be loaded either head to head or head to toe. 2. The noncandidate soldiers may assist the candidate by securing the litters to the vehicle. However, it is still the candidate's responsibility to ensure that the litters are properly secured.

c. Secure the first three litters individually to the seats and secure the other two litters on the floor together and to the seat with cravats using nonslip knots.

5. Raise and secure the tailgate.

**NOTE:** Time ends when the tailgate is secured.

**PERFORMANCE MEASURES:**

	<b>GO</b>	<b>NO GO</b>
1. Surveyed the casualties to determine loading sequence.	_____	_____
2. Secured the five casualties onto the litters.	_____	_____
3. Served as the number 1 person, giving the appropriate commands to the litter squad.	_____	_____
4. Configured and prepared the vehicle to receive casualties.	_____	_____
5. Loaded the casualties in the proper sequence.	_____	_____
6. Secured the casualties for transport.	_____	_____
7. Raised and secured the tailgate.	_____	_____
8. Did not cause further injury to the casualties.	_____	_____
9. Correctly performed all performance measures within 20 minutes.	_____	_____

**REFERENCES:**

**Required**

**Related**

FM 8-10-6

STP 8-91W15-SM-TG, Task No. 081-833-0172

---

Figure 3-37. Load Casualties Onto Nonstandard Vehicle  
(2 1/2-Ton, 6x6 or 5-Ton, 6x6, Cargo Truck).



**LOAD CASUALTIES ONTO NONSTANDARD VEHICLE  
(1 1/4-TON, 4X4, M998)**

**CONDITIONS:** Given a configured, nonstandard vehicle (without the cargo bow and canvas), three treated casualties, and three litters with straps and cravats. You and three noncandidate soldiers will form a litter squad, with you serving as the number 1 person to load the casualties.

**STANDARDS:** Prioritize, load, and secure three casualties within 15 minutes, in the proper sequence, without causing further injury to the casualties.

**PERFORMANCE STEPS:**

1. Survey the casualties to determine loading sequence.

**NOTE:** Time starts when the candidate starts surveying the casualties, starts the steps to secure the casualties onto the litters, or starts the steps to configure the vehicle.

2. Secure the three casualties onto the litters.

**NOTE:** The candidate may direct the noncandidates to secure the casualties while he or she configures and prepares the vehicle. However, it is still the candidate's responsibility to ensure that the casualties are properly secured to the litters.

3. Serve as the number 1 person and, with the assistance of the noncandidate soldiers, move the litters to the vehicle.

4. Load an M998 (Figure 3-38a).

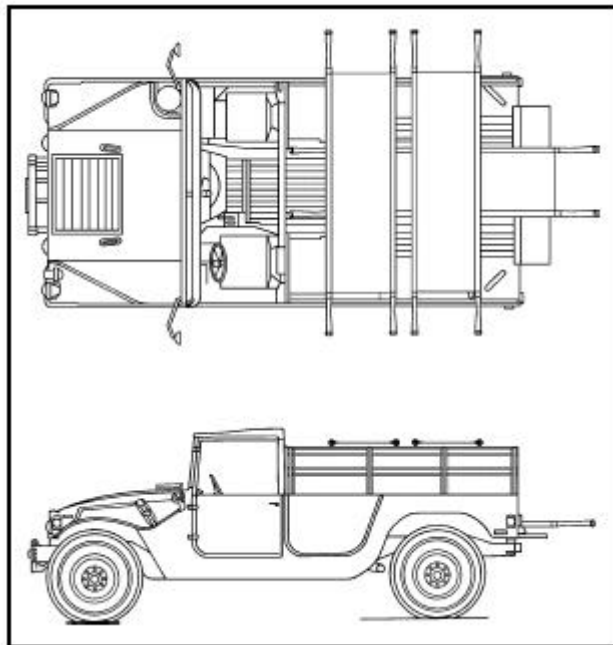

Figure 3-38a. 3-Casualty Configuration.

- a. Remove any debris and trash.
- b. Place two litters side-by-side across the back of the truck with the litter handles resting on the sides of the truck.

**NOTES:** 1. Casualties may be loaded either head to head or head to toe. 2. The noncandidate soldiers may assist the candidate by securing the litters to the vehicle. However, it is still the candidate's responsibility to ensure that the litters are properly secured.

- c. Secure the litters to the vehicle with cravats using nonslip knots.
- d. Place one litter lengthwise, head first, in the bed of the truck. Secure it in place.
- e. Leave the tailgate open. The two tailgate chain hooks will support it.

**NOTE:** Time ends when the last litter is secured.

**PERFORMANCE MEASURES:**

	<b>GO</b>	<b>NO GO</b>
1. Surveyed the casualties to determine loading sequence.	_____	_____
2. Secured the three casualties onto the litters.	_____	_____
3. Served as the number 1 person, giving the appropriate commands to the litter squad.	_____	_____
4. Removed debris and trash.	_____	_____
5. Loaded the casualties in the proper sequence.	_____	_____
6. Secured the casualties for transport.	_____	_____
7. Did not cause further injury to the casualties.	_____	_____
8. Correctly performed all performance measures within 15 minutes.	_____	_____

**REFERENCES:**

**Required**

**Related**

FM 8-10-6

STP 8-91W15-SM-TG, Task No. 081-833-0171

---

Figure 3-38. Load and Unload Casualties Onto Nonstandard Vehicles  
(1 1/4-Ton, 4x4, M998).

---

## PREPARE TO TRANSPORT A CASUALTY WITH A SUSPECTED SPINAL INJURY

**CONDITIONS:** Given a casualty with a suspected spinal injury, three noncandidate soldiers for assistance, and necessary materials and equipment.

**STANDARDS:** Complete all the necessary steps to immobilize and prepare a casualty with a suspected spinal injury for transport within 10 minutes, without causing further injury to the casualty.

### PERFORMANCE STEPS:

1. Place the casualty on a long spine board.
  - a. Place the spine board next to, and parallel with, the casualty.
  - b. Candidate will immobilize the casualty's head and neck using manual stabilization.
    - (1) Place his or her hands on both sides of the casualty's skull, with the palms over the ears.
    - (2) Support the jaw (mandible) with the fingers.
    - (3) Maintain manual stabilization until the casualty has been placed and secured on the spine board.
  - c. Candidate will instruct an assistant to apply a cervical collar.
  - d. Candidate will brief the three assistants on their duties and instruct them to kneel on the same side of the casualty, with the spine board on the opposite side of the casualty.
    - (1) First assistant. Place the near hand on the shoulder and the far hand on the waist.
    - (2) Second assistant. Place the near hand on the hip and the far hand on the thigh.
    - (3) Third assistant. Place the near hand on the knee and the far hand on the ankle.
  - e. On the candidate's command, and in unison, the assistants roll the casualty slightly toward them. Turn the casualty's head slightly, keeping it in a straight line with the spine.
  - f. Instruct the assistants to reach across the casualty with one hand, grasp the spine board at its closest edge, and slide it against the casualty. Instruct the number two assistant to reach across the board to the far edge and hold it in place to prevent board movement.
  - g. Instruct the assistants to slowly roll the casualty back onto the board. Keep the head and spine in a straight line.
  - h. Instruct the second assistant to place the casualty's wrists together at the waist and tie them together loosely.

**NOTE:** If the cervical collar or improvised collar does not fit flush with the spine board, place a roll in the hollow space between the neck and board. The roll should only be large enough to fill the gap, not to exert pressure on the neck.

2. Secure the casualty to the long spine board.

- a. Secure the casualty with straps across the chest, hips, thighs, and lower legs.

**NOTE:** Include the arms if the straps are long enough. If the spine board is not provided with straps and fasteners, use cravats or other long strips of cloth.

- b. Secure the casualty's head and head supports to the board with straps or cravats.

**WARNING:** DO NOT RELEASE MANUAL STABILIZATION UNTIL THE CRAVATS OR HEAD STRAPS ARE FIRMLY IN PLACE.

- (1) Apply head supports.
- (2) Use two rolled towels, blankets, sandbags, or similar material.
- (3) Place one close to each side of the head.

- (4) Using a cravat-like material across the forehead, make the supports and head one unit by tying to the board (Figure 3-39a).
3. Secure the casualty to a litter.

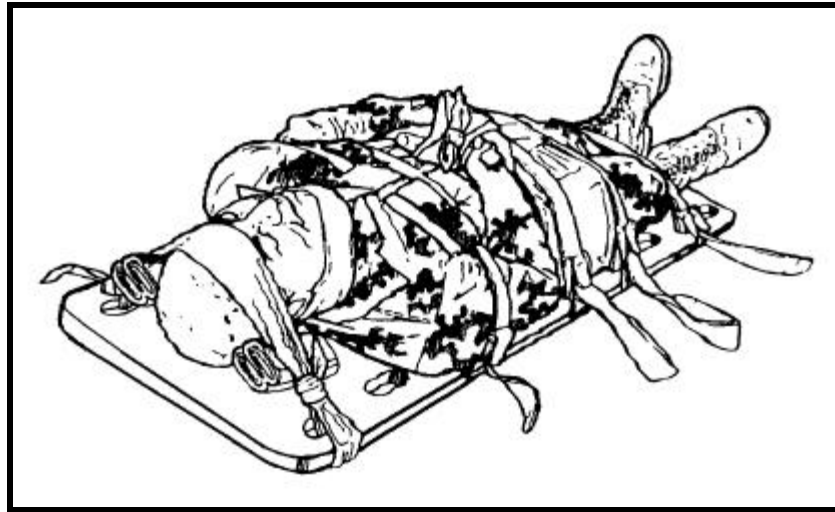

Figure 3-39a. Casualty on a Long Spine Board.

**PERFORMANCE MEASURES:**

1. Placed the casualty on the long spine board.
2. Secured the casualty on the long spine board.
3. Secured the casualty to a litter.
4. Did not cause further injury to the casualty.
5. Correctly performed all performance steps for each performance measure within 10 minutes.

<b>GO</b>	<b>NO GO</b>
_____	_____
_____	_____
_____	_____
_____	_____
_____	_____

**REFERENCES:**

**Required**

**Related**

STP 8-91W15-SM-TG, Task No. 081-833-0092  
 BTLS FOR PARAMEDICS  
 EMERGENCY CARE

---

Figure 3-39. Prepare to Transport a Casualty With a Suspected Spinal Injury.

---

## TRANSPORT A CASUALTY USING THE FIREMAN'S CARRY

**CONDITIONS:** Given an unconscious casualty without a spinal injury. You must manually transport the casualty without assistance.

**STANDARDS:** Transport the casualty 25 meters using the fireman's carry without dropping or causing further injury to the casualty.

**PERFORMANCE STEPS:**

1. Roll the casualty onto his or her abdomen. (The casualty will be lying on his or her back.)
  - a. Kneel at the casualty's uninjured side.
  - b. Place the casualty's arms above his or her head.
  - c. Cross the ankle that is farther from you over the one that is closer to you.
  - d. Place one of your hands on the casualty's shoulder that is farther from you; place your other hand in the area of the casualty's hip or thigh that is farther from you.
  - e. Roll the casualty gently toward you onto his or her abdomen.
2. After rolling the casualty onto his or her abdomen, straddle him or her.
3. Extend your hands under the casualty's chest and lock them together.
4. Lift the casualty to his or her knees as you move backward.
5. Continue to move backward, thus straightening the casualty's legs and locking his or her knees.
6. Walk forward, bringing the casualty to a standing position. Tilt the casualty backward slightly to prevent his or her knees from buckling.
7. As you maintain constant support of the casualty with one arm, free your other arm, quickly grasp the casualty's wrist, and raise his or her arm high. Instantly pass your head under the casualty's raised arm, releasing it as you pass under it.
8. Move swiftly to face the casualty and secure your arms around his or her waist. Immediately place one foot between the casualty's feet and spread them apart (approximately 6 to 8 inches).
9. Grasp the casualty's wrist and raise his or her arm high over your head.
10. Bend down and pull the casualty's arm over and down on your shoulder, bringing his or her body across your shoulders. At the same time, pass your arm between the casualty's legs.
11. Grasp the casualty's wrist with one hand, and place your other hand on your knee or weapon for support.
12. Rise with the casualty positioned correctly (Figure 3-40a).
13. Carry the casualty 25 meters without stopping and without causing further injury to the casualty.



Figure 3-40a. Fireman's Carry.

**PERFORMANCE MEASURES:**

1. Positioned the casualty for the carry.
2. Brought the casualty to a standing position.
3. Stepped around to face the casualty.
4. Lifted the casualty into the proper fireman's carry position.
5. Carried the casualty 25 meters without stopping.
6. Did not cause further injury to the casualty.

<b>GO</b>	<b>NO GO</b>
_____	_____
_____	_____
_____	_____
_____	_____
_____	_____
_____	_____

**REFERENCES:**

**Required**

**Related**

FM 4-25.11

FM 8-10-6

---

Figure 3-40. Transport a Casualty Using the Fireman's Carry.

**TRANSPORT A CASUALTY USING THE CRADLE DROP DRAG**

**CONDITIONS:** Given an unconscious casualty without a spinal injury. You must manually transport the casualty without assistance.

**STANDARDS:** Transport the casualty 25 meters using the cradle drop drag without dropping or causing further injury to the casualty.

**PERFORMANCE STEPS:**

1. Kneel at casualty's head with him or her lying on his or her back.
2. Slide your hands, palms up, under the casualty's shoulders and get a firm hold under his or her armpits.
3. Rise partially, supporting the casualty's head with your forearms, chest, or abdomen.
4. Rise and expediently drag the casualty backward with him or her in a semisitting position (Figure 3-41a) for 25 meters without causing further injury.



Figure 3-41a. Cradle Drop Drag.

**PERFORMANCE MEASURES:**

1. Knelt at the casualty's head.
2. Slid hands under the casualty's shoulders and got a firm hold under his or her armpits.
3. Rose partially, supporting the casualty's head.
4. Rose and drug the casualty backward, with him or her in a semisitting position.
5. Expediently transported the casualty 25 meters.
6. Did not cause further injury to the casualty.

GO	NO GO
_____	_____
_____	_____
_____	_____
_____	_____
_____	_____
_____	_____

**REFERENCES:**  
**Required**

**Related**  
FM 4-25.11  
FM 8-10-6

---

Figure 3-41. Transport a Casualty Using the Cradle Drop Drag.



### 3-15. LITTER OBSTACLE COURSE TASKS.

a. Objective. To measure the candidate's ability to evacuate and protect a casualty on a standard Army litter through an obstacle course in a battlefield scenario.

b. Requirements.

(1) Form the candidates into 4-person litter squads. There are eight tasks (see paragraph 3-15c) on the LOC and each candidate must correctly complete six of eight to receive a GO. The tasks will be tested in a simulated battlefield scenario with the required equipment IAW paragraphs 3-5 and 3-6.

(2) The test board will determine the order of the obstacles, the distance, and the grade of terrain between obstacles. Total distance traversed in the course must not exceed 1,090 yards (1 kilometer), nor will the total number of obstacles exceed eight.

(3) Non-LOC tasks may be incorporated before or after the course, but not during the course.

(4) The test board will establish a time limit. The time will be dependent on the course.

(5) The test board may modify a carry to conform with local conditions.

(6) The host unit will train the litter squad on the proper positions for the 4-person carry position along with commands to lift the litter ("Prepare to lift, LIFT"), move the litter ("4-Person Carry, MOVE"), and lower the litter ("Prepare to lower, LOWER").

(7) Each candidate on the litter squad is graded individually. The squad members are rotated after negotiating each obstacle so that each candidate is evaluated as the number 1, 2, 3, and 4 person. Only the number 1 person will provide the commands to the litter squad. Other members will not assist with the commands if the number 1 person forgets them. The commands for each obstacle (except the barbed wire obstacle) are listed in FM 8-10-6. The number 1 person, however, may issue additional commands or instructions to correct a deficiency or control the squad.

(a) Failure of the number 1 person to maintain control and provide guidance to the litter squad in negotiating the obstacle will result in a NO GO for that graded obstacle for that number 1 person.

(b) Assistance with commands from the number 2, 3, or 4 person to the number 1 person will result in a NO GO for that candidate and obstacle.

(8) Candidates will receive a NO GO for the entire LOC, not just the graded obstacle, for any of the following:

(a) Causing further injury to the casualty. Only the candidate(s) who caused the injury will receive the NO GO.

(b) Aggravating the current injury.

(c) Committing a safety violation as deemed by the test board.

(d) Exceeding the time limit established by the test board.

(9) Candidates will not serve as a casualty during test week.

(10) The casualty will have a leg injury that has been splinted. The casualty will weigh between 140 and 180 pounds (63.56 and 81.72 kilograms). Mannequins and sandbags will not be used.

c. Tasks. The following tasks are performed.

(1) Surmount a low wall obstacle (Figure 3-42).

(2) Surmount a high wall obstacle (Figure 3-43).

(3) Cross a trench obstacle (Figure 3-44).

(4) Transport a casualty through a narrow obstacle (Figure 3-45).

(5) Transport a casualty over rough terrain (Figure 3-46).

(6) Transport a casualty through a barbed wire obstacle (Figure 3-47).

(7) Transport a casualty uphill (Figure 3-48).

(8) Transport a casualty downhill (Figure 3-49).

**NOTE:** The test board chairperson will consider factors such as grade of incline and proposed length of obstacle to ensure that the obstacles in paragraphs 3-15c(5), 3-15c(7), and 3-15c(8) are safe and achievable.

d. Equipment. The host unit will provide one litter with straps for the litter squad at the start of the course.

e. Changes. Changes are NOT authorized without an exception to policy approval.

## SURMOUNT A LOW WALL OBSTACLE

**CONDITIONS:** Given a casualty on a standard Army litter and a low wall obstacle. Figure 3-42a is a suggested layout for the low wall obstacle.

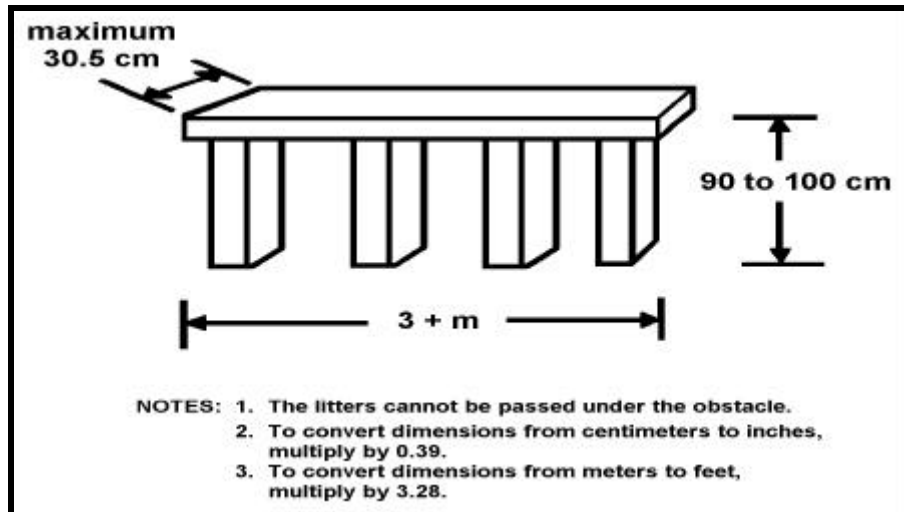

Figure 3-42a. Suggested Layout For the Low Wall Obstacle.

**STANDARDS:** Evacuate the casualty over the obstacle without causing further injury.

### PERFORMANCE STEPS:

1. Upon reaching the low wall, bearer number 1 instructs another bearer to clear any debris or obstacles immediately before the wall, at the wall, and beyond the wall, and to check for booby traps.
2. From the 4-person carry position, bearer number 1 gives the command "Litter Post, CARRY."
3. Bearer number 2 releases his or her grasp of the front handles and crosses the obstacle, maintaining a low silhouette (Figure 3-42b).

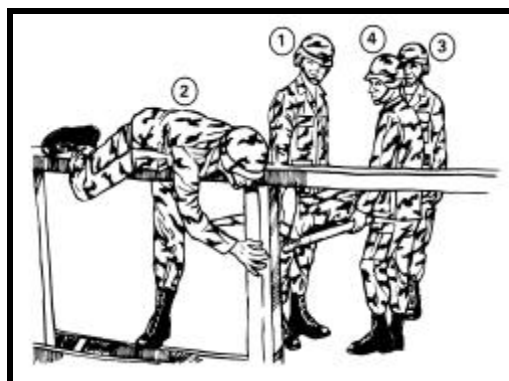

Figure 3-42b. Surmounting a Low Wall.

4. Bearer numbers 1, 3, and 4 advance the litter until bearer number 2 can resume his or her grip of the front handles.

5. The litter is rested on the obstacle with the stirrups placed on the side of the obstacle in the direction of travel.
6. Bearer numbers 2 and 3 support the litter by the front and rear handles, respectively.
7. Bearer numbers 1 and 4 cross the obstacle, maintaining a low silhouette.
8. After crossing the obstacle, bearer numbers 1 and 4 grasps the litter poles near the rear handles held by bearer number 3.
9. Bearer number 3 releases his or her grip of the rear handles and crosses the obstacle, maintaining a low silhouette (Figure 3-42c).

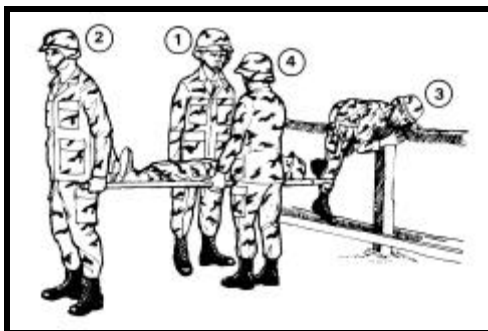

Figure 3-42c. Surmounting a Low Wall.

10. After crossing the obstacle, bearer number 3 resumes his or her grasp on the rear handles.
11. Bearer numbers 1 and 4 adjust the position of their holds.
12. All four bearers resume the 4-person carry.
13. Did not cause further injury to the casualty.

**PERFORMANCE MEASURES:**

1. Bearer number 1 instructed another bearer to clear all obstacles.
2. From the 4-person carry position, bearer number 1 gave the command "Litter Post, CARRY."
3. Bearer number 2 released his or her grasp of the front handles and crossed the obstacle, maintaining a low silhouette.
4. Bearer numbers 1, 3, and 4 advanced the litter until bearer number 2 could resume his or her grip of the front handles.
5. Rested the litter on the obstacle with the stirrups placed on the side of the obstacle in the direction of travel.
6. Bearer numbers 2 and 3 supported the litter by the front and rear handles, respectively.
7. Bearer numbers 1 and 4 crossed the obstacle, maintaining a low silhouette.
8. After crossing the obstacle, bearer numbers 1 and 4 grasped the litter poles near the rear handles held by bearer number 3.
9. Bearer number 3 released his or her grip of the rear handles and crossed the obstacle, maintaining a low silhouette.
10. After crossing the obstacle, bearer number 3 resumed his or her grasp on the rear handles.

<b>GO</b>	<b>NO GO</b>
-----------	------------------

_____	_____
_____	_____
_____	_____
_____	_____
_____	_____
_____	_____
_____	_____
_____	_____
_____	_____
_____	_____

**PERFORMANCE MEASURES:**

**GO**      **NO  
GO**

- |  |       |       |
|--|-------|-------|
| 11. Bearer numbers 1 and 4 adjusted the position of their holds. | _____ | _____ |
| 12. All four bearers resumed the 4-person carry.                 | _____ | _____ |
| 13. Did not cause further injury to the casualty.                | _____ | _____ |

**REFERENCES:**

**Required**

**Related**  
FM 8-10-6

---

Figure 3-42. Surmount a Low Wall Obstacle.

## SURMOUNT A HIGH WALL OBSTACLE

**CONDITIONS:** Given a casualty on a standard Army litter and a high wall obstacle. Figure 3-43a is a suggested layout for the high wall obstacle.

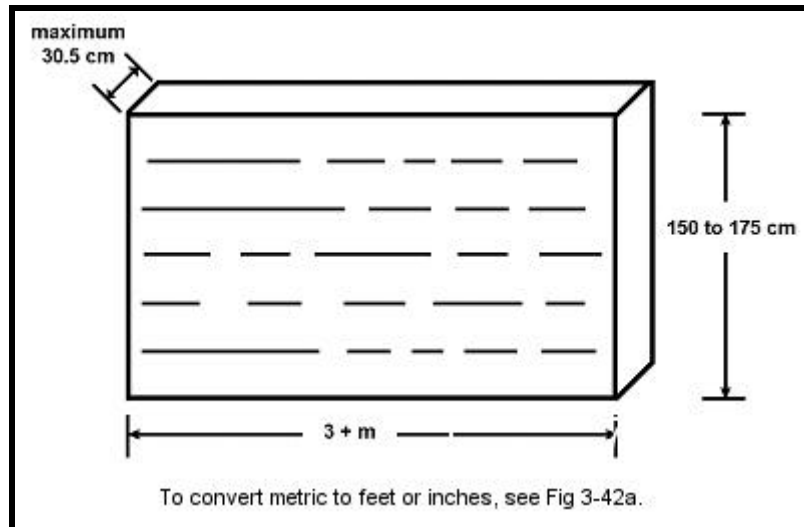

Figure 3-43a. Suggested Layout For the High Wall Obstacle.

**STANDARDS:** Evacuate the casualty over the obstacle without causing further injury.

**PERFORMANCE STEPS:**

1. Upon reaching the high wall, bearer number 1 instructs another bearer to clear any debris or obstacles immediately before the wall, at the wall, and beyond the wall, and to check for booby traps.
2. From the 4-person carry position, bearer number 1 gives the command "Semioverhead Carry, MOVE."
3. The bearers turn and face each other.
4. The bearers raise the litter approximately chest high and step close to the litter, letting their bent elbows touch their chests (Figure 3-43b).

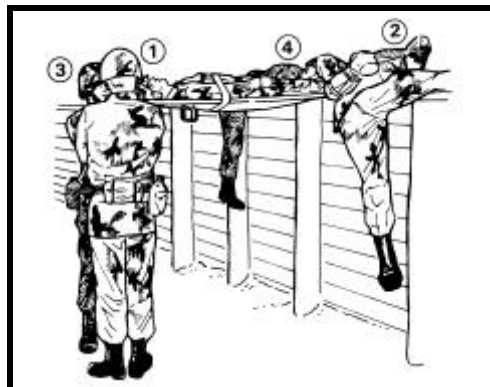

Figure 3-43b. Surmounting a High Wall Obstacle.

5. Bearer numbers 2 and 4 place the front stirrups beyond the wall.

6. Bearer numbers 2 and 4 scale the wall and drop to the other side, maintaining a low silhouette.
7. All four bearers move the litter forward until the rear stirrups are against the wall, taking care to avoid scraping the patient's back, by not dragging the litter across.
8. Bearer numbers 1 and 3 scale the wall and drop to the other side, maintaining a low silhouette.
9. Bearer numbers 1 and 3 lift their end of the litter off the wall.
10. All four bearers resume the 4-person carry.
11. Did not cause further injury to the casualty.

**PERFORMANCE MEASURES:**

	<b>GO</b>	<b>NO GO</b>
1. Bearer number 1 instructed another bearer to clear all obstacles.	_____	_____
2. From the 4-person carry position, bearer number 1 gave the command "Semioverhead Carry, MOVE."	_____	_____
3. The bearers turned and faced each other.	_____	_____
4. The bearers raised the litter approximately chest high and stepped close to the litter, letting their bent elbows touch their chests.	_____	_____
5. Bearer numbers 2 and 4 placed the front stirrups beyond the wall.	_____	_____
6. Bearer numbers 2 and 4 scaled the wall and dropped to the other side, maintaining a low silhouette.	_____	_____
7. All four bearers moved the litter forward until the rear stirrups were against the wall, taking care to avoid scraping the patient's back, by not dragging the litter across.	_____	_____
8. Bearer numbers 1 and 3 scaled the wall and dropped to the other side, maintaining a low silhouette.	_____	_____
9. Bearer numbers 1 and 3 lifted their end of the litter off the wall.	_____	_____
10. All four bearers resumed the 4-person carry.	_____	_____
11. Did not cause further injury to the casualty.	_____	_____

**REFERENCES:**

**Required**

**Related**  
FM 8-10-6

---

Figure 3-43. Surmount a High Wall Obstacle.

## CROSS A TRENCH OBSTACLE

**CONDITIONS:** Given a casualty on a standard Army litter and a trench obstacle. Figure 3-44a is a suggested layout for the trench obstacle.

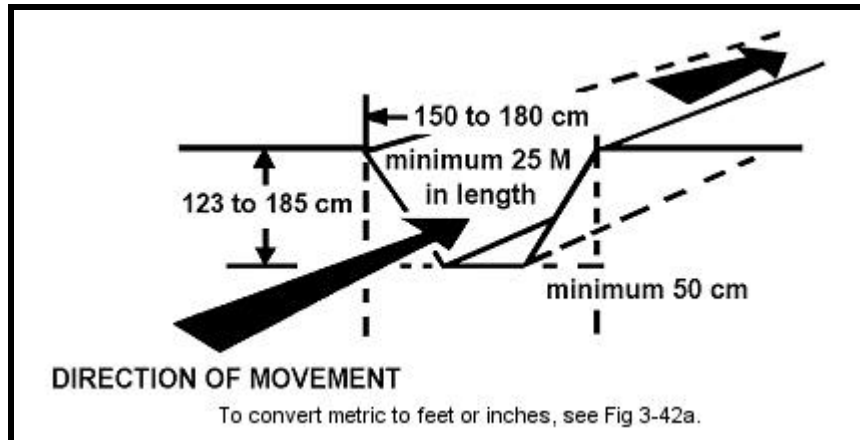

Figure 3-44a. Suggested Layout For the Trench Obstacle.

**STANDARDS:** Evacuate the casualty through the obstacle without causing further injury.

### PERFORMANCE STEPS:

1. Upon reaching the trench, bearer number 1 instructs another bearer to clear any debris or obstacles immediately before the trench, at the trench, and beyond the trench, and to check for booby traps.
2. From the 4-person carry position, bearer number 1 gives the command "Overhead Carry, MOVE."
3. The bearers turn and face the litter (Figure 3-44b).

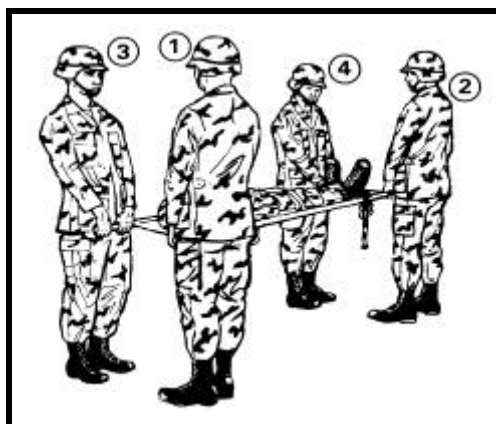

Figure 3-44b. Crossing a Trench.

4. Together, the squad lifts the litter above the top of the trench, keeping it level.
5. The taller bearer at each end of the litter moves between the handles, facing in the direction of travel.

**NOTE:** If unable to determine which bearer is taller, bearer number 1 will designate a bearer at each end as the tallest.



6. The taller bearer at each end grasps the handles as close to the canvas as possible.
7. The shorter bearer at each end moves under the litter, facing in the direction of travel.
8. The shorter bearer at each end grasps the stirrups, which compensates for the difference in height. If the bearers are of equal height, the bearers under the litter grasp the litter poles to the side of the stirrups nearer the ends (Figure 3-44c).

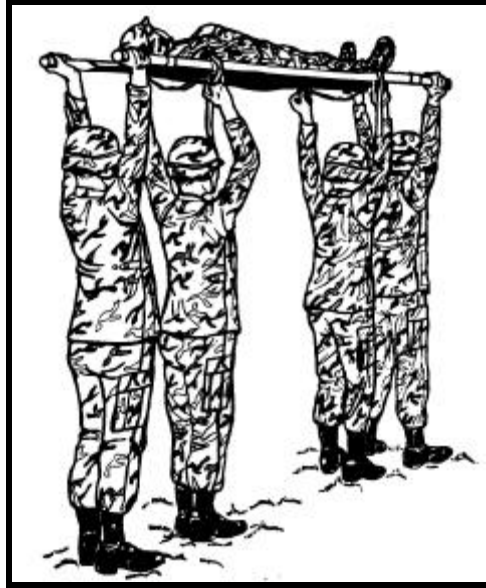

Figure 3-44c. Crossing a Trench.

9. The four bearers proceed through the obstacle completely in the overhead carry position.
10. After passing through the obstacle, the litter squad resumes the 4-person carry position.
11. Did not cause further injury to the casualty.

**PERFORMANCE MEASURES:**

	<b>GO</b>	<b>NO GO</b>
1. Bearer number 1 instructed another bearer to clear all obstacles.	_____	_____
2. From the 4-person carry position, bearer number 1 gave the command, "Overhead Carry, MOVE."	_____	_____
3. The bearers turned and faced each other.	_____	_____
4. Together, the squad lifted the litter above the top of the trench, keeping it level.	_____	_____
5. The taller bearer at each end of the litter moved between the handles, facing in the direction of travel.	_____	_____
6. The taller bearer at each end grasped the handles as close to the canvas as possible.	_____	_____
7. The shorter bearer at each end moved under the litter, facing in the direction of travel.	_____	_____

**PERFORMANCE MEASURES:**

**GO**      **NO  
GO**

- |   |       |       |
|---|-------|-------|
| 8. The shorter bearer at each end grasped the stirrups. If the bearers were of equal height, the bearers under the litter grasped the litter poles to the side of the stirrups nearer the ends. | _____ | _____ |
| 9. The four bearers proceeded through the obstacle completely in the overhead carry position.   | _____ | _____ |
| 10. After passing through the obstacle, the litter squad resumed the 4-person carry position.   | _____ | _____ |
| 11. Did not cause further injury to the casualty.   | _____ | _____ |

**REFERENCES:**

**Required**

**Related**  
FM 8-10-6

---

Figure 3-44. Cross a Trench Obstacle.

---

## TRANSPORT A CASUALTY THROUGH A NARROW OBSTACLE

**CONDITIONS:** Given a casualty on a standard Army litter and a narrow obstacle.

**STANDARDS:** Evacuate the casualty through the obstacle without causing further injury.

**PERFORMANCE STEPS:**

1. Upon reaching the narrow passage, bearer number 1 instructs another bearer to clear any debris or obstacles immediately before the passage, at the passage, and beyond the passage, and to check for booby traps.
2. From the 4-person carry position, bearer number 1 gives the command "2-Person Carry, MOVE."

**NOTE:** The 2-person carry is used to pass through or over narrow passages such as trails, bridges, gangplanks, and catwalks. With modification, it may also be used to pass through obstacles such as culverts and tunnels.

3. Bearer numbers 2 and 3 change their holds on the litter handles to the other hand.
4. Bearer numbers 2 and 3 step between the handles and take the full support of the litter.
5. Bearer numbers 1 and 4 release their holds.
6. Bearer number 1 steps one pace in front of the squad to lead.
7. Bearer number 4 falls one pace to the rear to follow.
8. The four bearers proceed through the obstacle (Figure 3-45a).

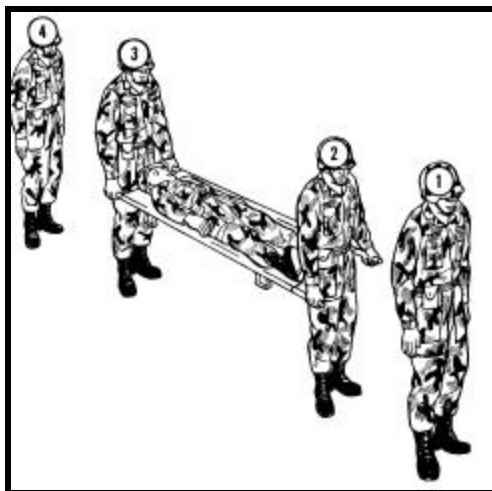

Figure 3-45a. Passing Through a Narrow Obstacle.

9. After passing through the obstacle, the litter squad resumes the 4-person carry position.
10. Did not cause further injury to the casualty.

**PERFORMANCE MEASURES:**

**GO**      **NO  
GO**

- |  |       |       |
|--|-------|-------|
| 1. Bearer number 1 instructed another bearer to clear all obstacles.                           | _____ | _____ |
| 2. From the 4-person carry position, bearer number 1 gave the command "2-Person Carry, MOVE."  | _____ | _____ |
| 3. Bearer numbers 2 and 3 changed their holds on the litter handles to the other hand.         | _____ | _____ |
| 4. Bearer numbers 2 and 3 stepped between the handles and took the full support of the litter. | _____ | _____ |
| 5. Bearer numbers 1 and 4 released their holds.  | _____ | _____ |
| 6. Bearer number 1 stepped one pace in front of the squad to lead.                             | _____ | _____ |
| 7. Bearer number 4 fell one pace to the rear to follow.  | _____ | _____ |
| 8. The four bearers proceeded through the obstacle.  | _____ | _____ |
| 9. After passing through the obstacle, the litter squad resumed the 4-person carry position.   | _____ | _____ |
| 10. Did not cause further injury to the casualty.  | _____ | _____ |

**REFERENCES:**

**Required**

**Related**

FM 8-10-6

---

Figure 3-45. Transport a Casualty Through a Narrow Obstacle.

---

**TRANSPORT A CASUALTY OVER ROUGH TERRAIN**

**CONDITIONS:** Given a casualty on a standard Army litter and a rough terrain obstacle.

**STANDARDS:** Evacuate the casualty over the obstacle without causing further injury.

**PERFORMANCE STEPS:**

1. From the 4-person carry position, bearer number 1 gives the command, "Litter Post Carry, MOVE."
2. Bearer numbers 2 and 3 change their holds on the litter handles to the other hand.
3. Bearer numbers 2 and 3 step between the handles and take the full support of the litter.
4. Bearer numbers 1 and 4 release their holds.
5. Bearer numbers 1 and 4 move to the sides of the litter and grasp the litter poles (Figure 3-46a).



Figure 3-46a. Litter Post Carry For Rough Terrain.

6. The four bearers proceed carefully over the obstacle.
7. After passing through the obstacle, the litter squad resumes the 4-person carry position.
8. Did not cause further injury to the casualty.

**PERFORMANCE MEASURES:**

**GO**      **NO  
GO**

- |   |       |       |
|---|-------|-------|
| 1. From the 4-person carry position, bearer number 1 gave the command, "Litter Post Carry, MOVE." | _____ | _____ |
| 2. Bearer numbers 2 and 3 changed their holds on the litter handles to the other hand.            | _____ | _____ |
| 3. Bearer numbers 2 and 3 stepped between the handles and took the full support of the litter.    | _____ | _____ |
| 4. Bearer numbers 1 and 4 released their holds.   | _____ | _____ |
| 5. Bearer numbers 1 and 4 moved to the sides of the litter and grasped the litter poles.          | _____ | _____ |
| 6. The four bearers proceeded carefully over the obstacle.  | _____ | _____ |
| 7. After passing through the obstacle, the litter squad resumed the 4-person carry position.      | _____ | _____ |
| 8. Did not cause further injury to the casualty.  | _____ | _____ |

**REFERENCES:**

**Required**

**Related**  
FM 8-10-6

---

Figure 3-46. Transport a Casualty Over Rough Terrain.

## TRANSPORT A CASUALTY THROUGH A BARBED WIRE OBSTACLE

**CONDITIONS:** Given a casualty on a standard Army litter and a barbed wire obstacle. Figure 3-47a is a suggested layout for the barbed wire obstacle.

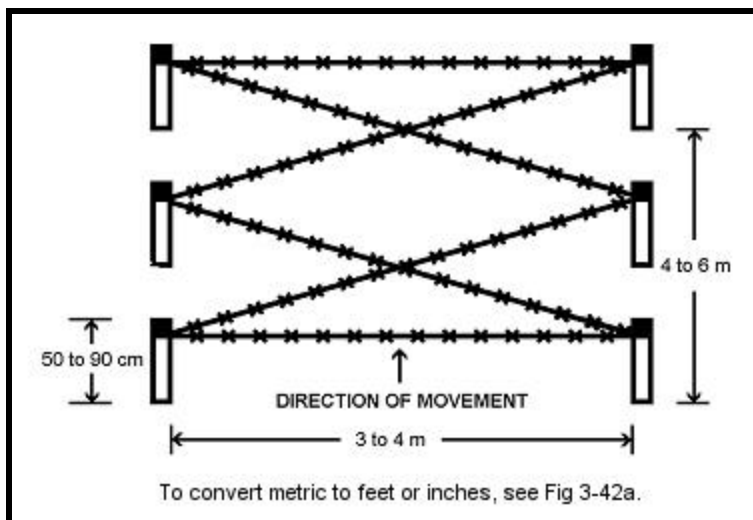

Figure 3-47a. Suggested Barbed Wire Obstacle Layout.

**STANDARDS:** Evacuate the casualty through a barbed wire obstacle using the low crawl carry without causing further injury.

### PERFORMANCE STEPS:

1. Upon reaching the barbed wire obstacle, bearer number 1 instructs another bearer to clear any debris or obstacles immediately before the wire, at the wire, and beyond the wire, and to check for booby traps.

**NOTE:** Prior to proceeding through the obstacle, the litter must be turned. The litter squad assumes the litter post carry position and then rotates the litter.

2. From the 4-person carry position, bearer number 1 gives the command, "Litter Post Carry, MOVE."

3. Bearer numbers 2 and 3 step between the handles of the litter and take hold of the handles.

4. Bearer numbers 1 and 4 release their holds on the litter.

5. Bearer numbers 1 and 4 move to the sides of the litter and grasp the litter poles.

6. Bearer number 1 gives the preparatory command, "Prepare To Rotate."

7. Bearer numbers 2 and 3 release the litter handles and step one pace away, allowing bearer numbers 1 and 4 to support the litter at its sides.

8. Bearer number 1 gives the command of execution, "ROTATE."

9. Bearer numbers 1 and 4 rotate the litter 180 degrees counterclockwise, placing the casualty's head in the direction of travel.

10. When the rotation is completed, bearer numbers 2 and 3 resume their positions at the litter handles. Bearer number 2 should now be at the casualty's head.

11. Bearer number 1 gives the preparatory command, "Low Crawl Carry."

12. The bearers, keeping the litter level, assume the low crawl carry position.

**NOTE:** The weapon must be carried and not slung on the back.

13. Bearer number 1 gives the command of execution, "MOVE."

14. The bearers extend their arms forward, grasp the litter handles, and move the litter forward.
15. Bearer number 1 gives the command, "LIFT."
16. The bearers lift the litter and move it forward; they do not drag it.
17. The bearers move forward using the low crawl.
18. No part of the casualty, the bearers, or their equipment should come into contact with the barbed wire. If something should become entangled, the bearers must free it before continuing.
19. The bearers repeat steps 15, 16, 17, and 18 until they clear the obstacle.
20. After clearing the obstacle, the bearers resume the 4-person carry.
21. Did not cause further injury to the casualty.

**PERFORMANCE MEASURES:**

	<b>GO</b>	<b>NO GO</b>
1. Bearer number 1 instructed another bearer to clear all obstacles.	_____	_____
2. From the 4-person carry position, bearer number 1 gave the command, "Litter Post Carry, MOVE."	_____	_____
3. Bearer numbers 2 and 3 stepped between the handles of the litter and took hold of the handles.	_____	_____
4. Bearer numbers 1 and 4 released their holds on the litter.	_____	_____
5. Bearer numbers 1 and 4 moved to the sides of the litter and grasped the litter poles.	_____	_____
6. Bearer number 1 gave the preparatory command, "Prepare To Rotate."	_____	_____
7. Bearer numbers 2 and 3 released the litter handles and stepped one pace away, allowing bearer numbers 1 and 4 to support the litter at its sides.	_____	_____
8. Bearer number 1 gave the command of execution, "ROTATE."	_____	_____
9. Bearer numbers 1 and 4 rotated the litter 180 degrees counterclockwise, placing the casualty's head in the direction of travel.	_____	_____
10. When the rotation is completed, bearer numbers 2 and 3 resumed their positions at the litter handles. Bearer number 2 is at the casualty's head.	_____	_____
11. Bearer number 1 gave the preparatory command, "Low Crawl Carry."	_____	_____
12. The bearers, keeping the litter level, assumed the low crawl carry position.	_____	_____
13. Bearer number 1 gave the command of execution, "MOVE."	_____	_____
14. The bearers extended their arms forward, grasped the litter handles, and moved the litter forward.	_____	_____
15. Bearer number 1 gave the command, "LIFT."	_____	_____
16. The bearers lifted the litter and moved it forward; they did not drag it.	_____	_____
17. The bearers moved forward using the low crawl.	_____	_____
18. If necessary, the bearers freed entangled equipment before continuing.	_____	_____



**PERFORMANCE MEASURES:**

**GO**      **NO  
GO**

- |  |       |       |
|--|-------|-------|
| 19. The bearers repeated steps 15, 16, 17, and 18 until they cleared the obstacle. | _____ | _____ |
| 20. After clearing the obstacle, the bearers resumed the 4-person carry.           | _____ | _____ |
| 21. Did not cause further injury to the casualty.                                  | _____ | _____ |

**REFERENCES:**

**Required**

**Related**  
FM 8-10-6

---

Figure 3-47. Transport a Casualty Through a Barbed Wire Obstacle.

---

## TRANSPORT A CASUALTY UPHILL

**CONDITIONS:** Given a casualty on a standard Army litter and an uphill obstacle.

**STANDARDS:** Evacuate the casualty uphill without causing further injury.

**PERFORMANCE STEPS:**

**NOTE:** The litter is normally carried uphill with the casualty's head forward. However, if the casualty has a fracture of the lower extremities, the litter is carried with the casualty's feet forward.

1. From the 4-person carry position, bearer number 1 gives the command, "Uphill Carry, MOVE."
2. Bearer number 2 changes his or her hold on the litter handle to the other hand.
3. Bearer number 2 steps between the handles and takes full support of the litter.
4. Bearer number 1 releases his or her hold.
5. Bearer number 1 steps one pace in front of the squad to lead.
6. The four bearers proceed uphill as shown in Figure 3-48a.



Figure 3-48a. Uphill Carry.

7. Bearer numbers 3 and 4 keep the litter level.
8. After clearing the obstacle, the bearers resume the 4-person carry.
9. Did not cause further injury to the casualty.

**PERFORMANCE MEASURES:**

	<b>GO</b>	<b>NO GO</b>
1. From the 4-person carry position, bearer number 1 gave the command, "Uphill Carry, MOVE."	_____	_____
2. Bearer number 2 changed his or her hold on the litter handle to the other hand.	_____	_____
3. Bearer number 2 stepped between the handles and took full support of the litter.	_____	_____
4. Bearer number 1 released his or her hold.	_____	_____
5. Bearer number 1 stepped one pace in front of the squad to lead.	_____	_____
6. The four bearers proceeded uphill.	_____	_____
7. Bearer numbers 3 and 4 kept the litter level.	_____	_____
8. After clearing the obstacle, the bearers resumed the 4-person carry.	_____	_____
9. Did not cause further injury to the casualty.	_____	_____

**REFERENCES:**

**Required**

**Related**  
FM 8-10-6

---

Figure 3-48. Transport a Casualty Uphill.

---

## TRANSPORT A CASUALTY DOWNHILL

**CONDITIONS:** Given a casualty on a standard Army litter and a downhill obstacle.

**STANDARDS:** Evacuate the casualty downhill without causing further injury.

**PERFORMANCE STEPS:**

**NOTE:** The litter is normally carried downhill with the casualty's feet forward. However, if the casualty has a fracture of the lower extremities, the litter is carried with the casualty's head forward.

1. From the 4-person carry position, bearer number 1 gives the command, "Litter Post Carry, MOVE."
2. Bearer numbers 2 and 3 step between the handles of the litter and take hold of the handles.
3. Bearer numbers 1 and 4 release their hold of the litter.
4. Bearer numbers 1 and 4 move to the sides of the litter and grasp the litter poles.
5. Bearer number 1 gives the preparatory command, "Prepare To Rotate."
6. Bearer numbers 2 and 3 release the litter handles and step one pace away, allowing bearer numbers 1 and 4 to support the litter at its sides.
7. Bearer number 1 gives the command of execution, "ROTATE" (Figure 3-49a).

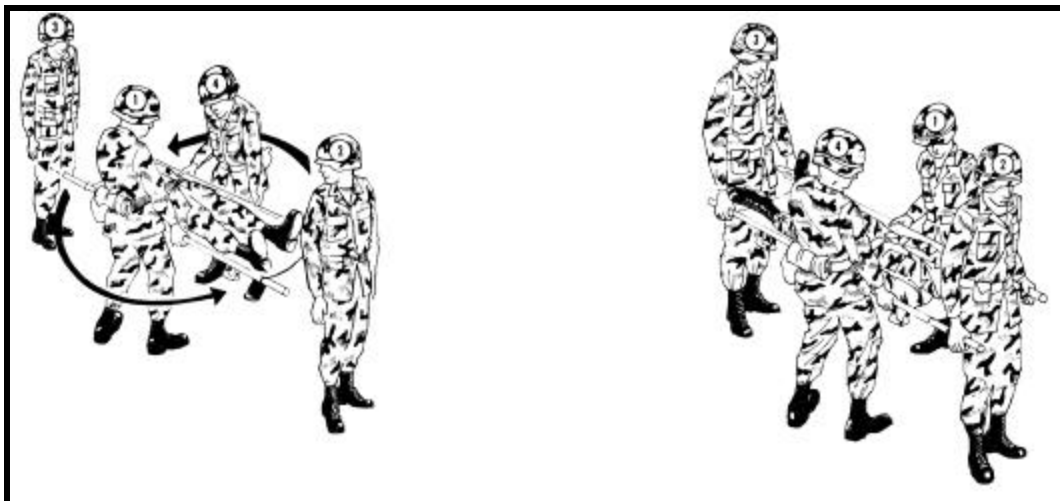

Figure 3-49a. Litter Rotation.

8. Bearer numbers 1 and 4 rotate the litter 180 degrees counterclockwise, placing the casualty's head in the direction of travel.
9. Bearer number 1 gives the command "Downhill Carry, MOVE."
10. Bearer number 3 takes full support of the litter at the casualty's feet.
11. Bearer numbers 2 and 4 take the litter handles at the casualty's head.
12. Bearer number 1 moves to the front and faces the squad.
13. When all four bearers are in position, they proceed downhill with the litter.
14. Bearer numbers 2 and 4 keep the litter level as they proceed downhill.
15. Bearer number 1 supports bearer numbers 2 and 4 and ensures that they keep the litter level.
16. After clearing the obstacle, the bearers resume the 4-person carry.
17. Did not cause further injury to the casualty.

**PERFORMANCE MEASURES:**

	<b>GO</b>	<b>NO GO</b>
1. From the 4-person carry position, bearer number 1 gave the command, "Litter Post Carry, MOVE."	_____	_____
2. Bearer numbers 2 and 3 stepped between the handles of the litter and took hold of the handles.	_____	_____
3. Bearer numbers 1 and 4 released their hold of the litter.	_____	_____
4. Bearer numbers 1 and 4 moved to the sides of the litter and grasped the litter poles.	_____	_____
5. Bearer number 1 gave the preparatory command, "Prepare To Rotate."	_____	_____
6. Bearer numbers 2 and 3 released the litter handles and stepped one pace away, allowing bearer numbers 1 and 4 to support the litter at its sides.	_____	_____
7. Bearer number 1 gave the command of execution, "ROTATE."	_____	_____
8. Bearer numbers 1 and 4 rotated the litter 180 degrees counterclockwise, placing the casualty's head in the direction of travel.	_____	_____
9. Bearer number 1 gave the command "Downhill Carry, MOVE."	_____	_____
10. Bearer number 3 took full support of the litter at the casualty's feet.	_____	_____
11. Bearer numbers 2 and 4 took the litter handles at the casualty's head.	_____	_____
12. Bearer number 1 moved to the front and faced the squad.	_____	_____
13. When all four bearers were in position, they proceeded downhill with the litter.	_____	_____
14. Bearer numbers 2 and 4 kept the litter level as they proceeded downhill.	_____	_____
15. Bearer number 1 supported bearer numbers 2 and 4 and ensured that they kept the litter level.	_____	_____
16. After clearing the obstacle, the bearers resumed the 4-person carry.	_____	_____
17. Did not cause further injury to the casualty.	_____	_____

**REFERENCES:**

**Required**

**Related**  
FM 8-10-6

---

Figure 3-49. Transport a Casualty Downhill.

**THIS PAGE LEFT INTENTIONALLY BLANK**

### 3-16. FOOT MARCH.

a. Objective. To measure a candidate's physical stamina, state of training, and mental attitude.

b. Requirements. Candidates must complete a 12-mile (19.3 kilometers) foot march, in 3 hours, carrying their individual field equipment IAW paragraph 3-5. This event is the last event tested during test week.

(1) Test board members will verify the march route to 63,360 feet (12 miles or 19,308 meters) with a calibrated measuring wheel. A vehicle odometer will not be used. Markers will be placed at each mile along the route.

(2) The test board chairperson will develop a thorough risk assessment and revise it, as necessary, depending on weather conditions. The risk for heat injuries is always present in strenuous events. Occurrences rise rapidly when the wet bulb globe temperature (WBGT) reaches 65°F. Risk reduction measures, such as unblousing the pants, are allowed. The test board chairperson may approve these measures as weather conditions necessitate.

(3) Standing operating procedures must be developed for the provision of medical care. Measures include WBGT readings, treatment of injuries, and evacuation procedures and routes. Active surveillance of the participants along the march route is essential. Sufficient ice must be available for immediate body cooling. Intravenous and oral fluids must be readily available for immediate rehydration. Automated defibrillation should be available if transport to an acute care life support-qualified medical facility cannot be accomplished in less than 6 minutes. Position a combat lifesaver or medic, with aid bag, at each water point. They should have a radio or telephone for communications with the tactical operations center. These personnel must be able to recognize the initial stages of heat injuries and take appropriate action. An aid station should be set up at the end of the march to evaluate the candidates for injuries, dehydration, confusion or disorientation, and temperature before releasing them. Immediate IV rehydration is extremely beneficial.

(4) Proper hydration procedures must be enforced. On the day before the march, candidates should consume several quarts (liters) of water. On the morning of the march, candidates should consume 1 or 2 quarts of water. They should consume at least 1 quart (.9 liter) an hour during the march, preferably drinking some every 15 to 30 minutes. Maximum consumption should not exceed 1.25 quarts (1.18 liters) an hour or 12 quarts (11.35 liters) a day. Actual amounts required will vary with the individual and weather conditions.

(5) The host unit will have a minimum of two stopwatches, a primary and an alternate, to maintain the official march time. The time starts when the last candidate crosses the start line. Elapsed time readings are recommended because they assist the candidates in pacing themselves.

(6) The host unit will brief the candidates in detail on the route, mile markers, water points, and direction changes. (A strip map of the route will be provided.)

(7) Only candidates, march cadre, test board members, and medical support personnel are allowed on the course during the march.

(8) Candidates must start and finish the course with the equipment in Table 3-1. The host unit will conduct a uniform and equipment inspection prior to and at the end of the march.

(9) Candidates must carry their weapon "at the ready." They will not strap the weapon to the rucksack, disassemble the weapon, or carry the weapon at sling arms.

(10) Candidates must carry the protective mask with carrier strapped around their waist or shoulder.

(11) Candidates will not be assisted during the march in any way. This includes, but is not limited to, adjusting their equipment for them and providing items such as dry socks, food, or drink. Candidates must secure their own water or refill their canteens at authorized water stations. Candidates may carry additional items for their own consumption, such as sports drinks and energy bars. However, they must carry these additional items and have them on their person prior to beginning the march. Candidates may not receive additional items after the march starts.

(12) A rest or sleep period must be afforded the candidates prior to the march. The duration of this rest or sleep period will be at least 4 to 6 continuous hours.

(13) The candidate will receive a NO GO for any of the following:

(a) Not completing the entire road march route.

(b) Not completing the road march within the 3-hour time limit.

(c) Not starting and finishing with the equipment listed in Table 3-1.

(d) Receiving assistance along the route.

(e) Not carrying the weapon and mask as stated in paragraphs 3-16b(9) and 3-16b(10).

c. Equipment. The host unit will provide all equipment and supplies to administer the road march.

d. Changes. Changes are NOT authorized without an exception to policy approval.



**APPENDIX A**  
**REFERENCES**

**Section I**  
**Required Publications**

**AR 25-55**

The Department of the Army Freedom of Information Act Program

**AR 600-8-22**

Military Awards

**AR 670-1**

Wear and Appearance of Army Uniforms and Insignia

**CTA 50-900**

Clothing and Individual Equipment

**FM 3-3**

Chemical and Biological Contamination Avoidance

**FM 3-3-1**

Nuclear Contamination Avoidance

**FM 3-21.38**

Pathfinder Operations

**FM 3-22.9**

Rifle Marksmanship M16A1, M16A2/3, M16A4 and M4 Carbine

**FM 4-25.11**

First Aid

**FM 8-10-6**

Medical Evacuation in a Theater of Operations Tactics, Techniques, and Procedures

**FM 8-285**

Treatment of Chemical Agent Casualties and Conventional Military Chemical Injuries

**FM 21-20**

Physical Fitness Training

**FM 25-101**

Battle Focused Training

**FM 100-14**

Risk Management

**FM 101-5**

Staff Organization and Operations

**GTA 03-06-008**

NBC Warning and Reporting System (This graphic training aid may be downloaded off Reimer's Digital Library on the Army Training Support Center's website)

**GTA 05-02-012**

Coordinate Scale and Protractor (Simple Device) (This graphic training aid may be obtained from the installation Training Audiovisual Support Center.

**GTA 08-01-004**

MEDEVAC Request Form (This graphic training aid may be downloaded off Reimer's Digital Library on the Army Training Support Center's website)

**TC 25-20**

A Leader's Guide to After Action Reviews

**TM 3-4240-300-10-2**

Operator's Manual for Chemical-Biological Mask Combat Vehicle, M42 (NSN 4240-01-258-0064) Small, (4240-01-258-0065) Medium, (4240-01-258-0066) Large

**Section II**

**Related Publications**

A related publication is merely a source of additional information. The user does not have to read it to understand this publication

**AR 40-66**

Medical Record Administration and Health Care Documentation

**FM 3-5**

NBC Decontamination

**FM 3-11.4**

Multiservice Tactics, Techniques, and Procedures for Nuclear, Biological, and Chemical (NBC) Protection

**FM 3-23.35**

Combat Training with Pistols, M9 and M11

**FM 3-25.26**

Map Reading and Land Navigation

**FM 4-02**

Force Health Protection in a Global Environment

**FM 7-8**

Infantry Rifle Platoon and Squad

**FM 21-60**

Visual Signals

**FM 21-75**

Combat Skills of the Soldier

**STP 3-54B1-SM**

Chemical Operations Specialist, Skill Level 1, Soldier's Manual

**STP 7-11BCHM1-SM**

Soldier's Manual, MOS 11B, 11C, 11H, and 11M, Infantry Skill Level 1

**STP 8-91W15-SM-TG**

Soldier's Manual and Trainer's Guide, MOS 91W, Health Care Specialist, Skill Levels 1/2/3/4/5

**STP 21-1-SMCT**

Soldier's Manual of Common Tasks Skill Level 1

**STP 21-24-SMCT**

Soldier's Manual of Common Tasks (SMCT) Skill Levels 2-4

**TB 11-5820-890-12**

Operator and Unit Maintenance for AN/CYZ-10 Automated Net Control Device (ANCD) (NSN 5810-01-343-1194) (EIC: QSU) with the Single Channel Ground and Airborne Radio Systems (SINCGARS)

**TM 3-4230-229-10**

Operator's Manual for Decontaminating Kit, Skin: M291, (NSN 4230-01-251-8702)

**TM 3-4230-235-10**

Operator's Manual for Decontamination Kit, Individual Equipment: M295 (NSN 6850-01-357-8456)

**TM 3-4240-279-10**

Operator's Manual for Mask, Chemical-Biological: Field, ABC-M17 (NSN 4240-00-542-4450) Small; (4240-00-542-4451) Medium; (4240-00-542-4452) Large; M17A1 (4240-00-926-4199) Small; (4240-00-926-4201) Medium; (4240-00-926-4200) Large; M17A2 (4240-01-143-2017) X-Small; (4240-01-143-2018) Small; (4240-01-143-2019) Medium; (4240-01-143-2020) Large

**TM 3-4240-280-10**

Operator's Manual for Mask, Chemical-Biological: Aircraft, ABC-M24 and Accessories and Mask, Chemical-Biological, Tank, M25A1 and Accessories

**TM 3-4240-346-10**

Operator's Manual for Chemical-Biological Mask: Field, M40A1 (NSN 4240-01-370-3821-Small) (4240-01-370-3822-Medium) (4240-01-370-3823-Large); Chemical-Biological Mask: Combat Vehicle, M42A2 (4240-01-4100-Small) (4240-01-413-4101-Medium) (4240-01-413-4102-Large)

**TM 9-1005-249-10**

Operator's Manual for Rifle, 5.56-mm, M16 (NSN 1005-00-856-6885) Rifle, 5.56-mm, M16A1 (1005-00-073-9421)

**TM 9-1005-317-10**

Operator's Manual for Pistol, Semiautomatic, 9mm, M9 (NSN 1005-01-118-2640)

**TM 9-1005-319-10**

Operator's Manual for Rifle, 5.56mm, M16A2 W/E (NSN 1005-01-128-9936) (EIC: 4GM); Rifle, 5.56mm, M16A3 (1005-01-357-5112); Rifle, 5.56mm, M16A4 (1005-01-383-2872) (EIC: 4F9) ; Carbine, 5.56mm, M4 W/E (1005-01-231-0973) (EIC: 4FJ); Carbine, 5.56mm, M4A1 (1005-01-382-0953) (EIC: 4GC)

**TM 11-5820-890-10-8**

Operator's Manual for SINGARS Ground Combat Net Radio, ICOM Manpack Radio, AN/PRC-119A (NSN 5820-01-267-9482) (EIC: L2Q), Short Range Vehicular Radio AN/VRC-87A (5820-01-267-9480) (EIC: L22), Short Range Vehicular Radio with Single Radio Mount AN/VRC-87C (5820-01-304-2045) (EIC: GDC), Short Range Vehicular Radio with Dismount AN/VRC-88A (5820-01-267-9481) (EIC: L23), Short Range/Long Range Vehicular Radio AN/VRC-89A (5820-01-267-9479) (EIC: L24), Long Range Vehicular Radio AN/VRC-90A (5820-01-268-5105) (EIC: L25) Short Range/Long Range Vehicular Radio with Dismount AN/VRC-91A (5820-01-267-9478) (EIC: L26), Short Range/Long Range Vehicular Radio AN/VRC-92A (5820-01-267-9477) (EIC: L27) used with Automated Net Control Device (ANCD) (AN/CYZ-10) Precision Lightweight GPS Receiver (PLGR) (AN/PSN-11) Secure Telephone Unit (STU) Frequency Hopping Multiplexer (FHMUX)

**Basic Nursing**

Caroline Rosdahl, Textbook of Basic Nursing, 6th edition, Lippincott, Williams, and Wilkins, 1 August 1997

**BTLS for Paramedics**

John Campbell, Basic Trauma Life Support for Paramedics and Other Advanced Providers, 4th edition, Prentice Hall, 1 August 1999

**Emergency Care**

Michael O'Keefe (Editor), Brady Emergency Care, 8th Edition, Prentice Hall, 1 July 1997

**Section III**

**Prescribed Forms**

**AMEDDC&S Form 1232-R**

Expert Field Medical Badge Qualification Record

**Section IV**

**Referenced Forms**

**DD Form 1380**

U.S. Field Medical Card

**APPENDIX B**

**GLOSSARY**

**Section I  
Abbreviations**

AHA .....	American Heart Association
AHS .....	Academy of Health Sciences
AMEDD .....	Army Medical Department
AMEDDC&S.....	U.S. Army Medical Department Center and School
ANCD .....	automated net control device
AOC .....	area of concentration
APFT .....	Army Physical Fitness Test
AR.....	Army regulation
ASIP .....	Advanced System Improvement Program
ATNAA .....	antidote treatment, nerve agent, autoinjectors
BDU .....	battle dress uniform
BTLS.....	basic trauma life support
cm .....	centimeters
COMSEC.....	communications security
CPR .....	cardiopulmonary resuscitation
CPT.....	captain
CTA.....	common table of allowances
CVC .....	combat vehicle crewman
DA.....	Department of the Army
DD.....	Department of Defense
DSN .....	defense switched network
DVC .....	device

EFMB.....	Expert Field Medical Badge
FH.....	frequency hop
FM.....	field manual
FRAGO .....	fragmentary order
GTA .....	graphic training aid
IAW .....	in accordance with
IEDK .....	individual equipment decontamination kit
IV .....	intravenous
LCE.....	load-carrying equipment
LOC .....	litter obstacle course
MEDEVAC.....	medical evacuation
mm .....	millimeters
MOPP.....	mission-oriented protective posture
MOS.....	military occupational specialty
NBC .....	nuclear, biological, and chemical
NCOIC .....	noncommissioned officer in charge
NSN .....	national stock number
OIC.....	officer in charge
OPORD .....	operation order
pam.....	pamphlet
SDK .....	skin decontaminating kit
SFC.....	sergeant first class
SINGARS .....	single channel ground and airborne radio system
SMCT .....	Soldier's Manual of Common Tasks
SOI.....	signal operation instructions
SOP .....	standing operating procedure

SPC .....	specialist
SSN .....	social security number
STP .....	soldier training publication
TC .....	training circular
TCO .....	test control office(r)
TM.....	technical manual
WBGT.....	wet bulb globe temperature
WQ.....	weapons qualification
WT .....	written test
2 PAM Cl.....	pralidoxime chloride

**Section II**  
**Terms**

Battlefield scenario. Simulated combat conditions and situations created for evaluating soldiers on tasks.

Combat lane. A path or trail used to evaluate candidates on a set of tasks under simulated combat conditions.

Esprit de corps. The common spirit existing in members of a group that inspires devotion, enthusiasm, and strong regard for the honor of the group.

Lane validation. The validation process conducted by the EFMB Test Board prior to the standardization and test week to ensure that tasks are tested IAW this pam.

Moulage. A simulation of a medical wound or injury used as a training aid.

Reaction-style testing. Simulated combat conditions that are created in which soldiers are tested against preestablished standards for reaction performance.

Standardization review. A review conducted by the TCO to ensure that EFMB tests are administered consistently throughout the Army IAW this pam.

Standardization week. The week prior to test week in which candidates are shown the tasks, conditions, and standards on which they are to be evaluated.

Test deviation. A deviation from the standards outlined in this pam during testing.

**THIS PAGE LEFT INTENTIONALLY BLANK**



**APPENDIX C**

**EXPERT FIELD MEDICAL BADGE QUALIFICATION RECORD**

For use of this form, see AMEDDC&S Pam 350-10, the proponent is MCCS-HT

**PRIVACY ACT STATEMENT**

AUTHORITY: 5 U.S.C., section 301.

PURPOSE: To award the individual the Expert Field Medical Badge.

ROUTINE USES: To provide the local PAC this information so orders are issued for award of the badge.

MANDATORY OR VOLUNTARY DISCLOSURE AND EFFECT ON INDIVIDUAL NOT PROVIDING INFORMATION: While the individual has the right to refuse disclosure of his/her Social Security Number, this information is needed to issue the orders. Failure to provide the Social Security Number may result in denial of the award of the badge.

1. THRU	2. TO	3. FROM	
4. NAME (Last, First, MI)	5. GRADE	6. MOS	7. SSN
8. UNIT			

CRITICAL PERFORMANCE AREAS AND TASKS	TEST REQUIREMENTS	TEST DATE (YYYYMMDD)	GO	NO GO	CANDIDATE SCORE
9. ARMY PHYSICAL FITNESS TEST	180 POINTS (60 PER EVENT)				
10. WEAPONS QUALIFICATION	MARKSMAN				
11. CARDIOPULMONARY RESUSCITATION CERTIFICATION	CURRENT				
12. WRITTEN TEST	75 OF 100				
13. LAND NAVIGATION TASKS					
a. Navigate from one point to another during the day	3 OF 4 POINTS				
b. Navigate from one point to another during the night	3 OF 4 POINTS				
14. COMMUNICATION TASKS	3 OF 4 TASKS				
a. Assemble and operate a SINCGARS or SINCGARS (ASIP) without ANCD					
b. Load FH/COMSEC data and conduct radio check using SINCGARS or SINCGARS (ASIP)					
c. Prepare and transmit a MEDEVAC request					
d. Submit NBC 1 report					
15. COMMON SKILLS TASKS	9 OF 12 TASKS				
a. Protect yourself from chemical/biological contamination using your assigned protective mask					
b. Decontaminate yourself using chemical decontaminating kits					
c. Protect yourself from NBC injury/contamination with MOPP gear					
d. Perform self -aid for mild nerve agent poisoning					
e. Protect yourself from biological or chemical injury/contamination when removing MOPP gear					
f. Store the M40-series protective mask with hood					
g. Correct malfunction of an M4 carbine or M16-series rifle					
h. Disassemble and assemble an M9 pistol and perform a function check					
i. Camouflage yourself and your individual equipment					
j. Move under direct fire					
k. Disassemble and assemble an M16-series rifle or M4/M4A1 carbine					
l. Perform a function check on an M16-series rifle or M4/M4A1 carbine					

CRITICAL PERFORMANCE AREAS AND TASKS	TEST REQUIREMENTS	TEST DATE (YYYYMMDD)	GO	NO GO	CANDIDATE SCORE
<b>16. EMERGENCY MEDICAL TREATMENT TASKS</b>	<b>8 OF 10 TASKS</b>				
a. Triage casualties on a conventional battlefield					
b. Perform a casualty assessment					
c. Control bleeding					
d. Treat a casualty with an open chest wound					
e. Treat a casualty with an open abdominal wound					
f. Immobilize a suspected fracture of the arm					
g. Initiate treatment for hypovolemic shock					
h. Treat a casualty with an open head injury					
i. Initiate an IV infusion					
j. Initiate a Field Medical Card					
<b>17. EVACUATION OF THE SICK AND WOUNDED TASKS</b>	<b>6 OF 8 TASKS</b>				
a. Establish a helicopter landing point					
b. Load casualties onto a UH 60 helicopter					
c. Load casualties onto ground evacuation platform (M996, M997, or M113)					
d. Load casualties onto nonstandard vehicle (5-Ton M-1085, M-1093, or 2 ½-Ton M-1081) or (2 ½-ton, 6x6 or 5-ton, 6x6, cargo truck)					
e. Load casualties onto nonstandard vehicle (1 ¼-ton, 4x4, M-998)					
f. Prepare to transport a casualty with a suspected spinal injury					
g. Transport a casualty using the fireman's carry					
h. Transport a casualty using the cradle drop drag					
<b>18. LITTER OBSTACLE COURSE TASKS</b>	<b>6 OF 8 TASKS</b>				
a. Surmount a low wall obstacle					
b. Surmount a high wall obstacle					
c. Cross a trench obstacle					
d. Transport a casualty through a narrow obstacle					
e. Transport a casualty over rough terrain					
f. Transport a casualty through a barbed wire obstacle					
g. Transport a casualty uphill					
h. Transport a casualty downhill					
<b>19. FOOT MARCH</b>	<b>3 HOURS</b>				
20. <input type="checkbox"/> QUALIFIED <input type="checkbox"/> NOT QUALIFIED FOR AWARD OF EFMB (IAW AMEDDC&S PAM 350-10)					
21. REMARKS					
22. TYPED NAME, GRADE, AND BRANCH OF EFMB CHAIRPERSON		23. SIGNATURE		24. DATE (YYYYMMDD)	

**The proponent of this pamphlet is the Department of Training Support, Academy of Health Sciences, U.S. Army Medical Department Center and School. Users are invited to send comments and suggested improvements on DA Form 2028, Recommended Changes to Publications and Blank Forms, to Commandant, Academy of Health Sciences, ATTN: MCCS-HTU, 1750 Greeley Road, Suite 135, Fort Sam Houston, TX 78234-5078.**

FOR THE COMMANDER:

OFFICIAL:

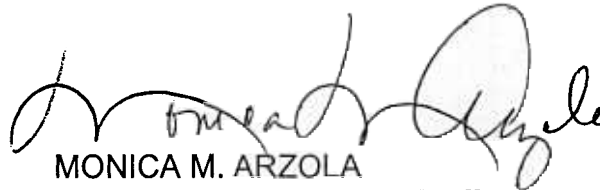
A handwritten signature in black ink, appearing to read "Monica M. Arzola". The signature is fluid and cursive, with a large loop at the end.

MONICA M. ARZOLA  
Secretary of the General Staff

DISTRIBUTION:  
2 - MCCS-BHR-PA (Mrs. Walker)